

# Environmental Services essentials



Your guide to choosing the right EVS products and solutions



# You're on the frontlines of healthcare

And so are we

## Cleaning protocols, hand hygiene and surface disinfection

When it comes to managing Environmental Services, patient and staff safety are priority number one. So it's important to identify the right products and best practices to help you achieve your goals.

### What does it take to succeed? A dedicated partner who understands healthcare and EVS needs

#### Discover better options

**Innovations designed to help you achieve your goals**—we own patents in many environmental services categories

#### Learn best practices

**Solid advice and valuable insights**—our team of EVS specialists has many years of combined healthcare industry experience

#### Consolidate orders

**Everything you need in one invoice**—we provide over 335,000 products to the entire continuum of care

#### Control costs

**Low minimums for free shipping**—qualifying is easy if you include your med-surg supplies



<b>Paper Supplies</b>	<b>4-11</b>
<b>Liners, Hampers and Trash Cans</b>	<b>12-31</b>
<b>Cleaning Tools and Cart Necessities</b>	<b>32-39</b>
<b>Floor care</b>	<b>40-60</b>
<b>Microfiber</b>	<b>61-69</b>
<b>Carts and Containers</b>	<b>70-84</b>
<b>Surface Cleaning Chemicals and Disinfectants</b>	<b>85-113</b>
<b>Soap and Hand Hygiene Products</b>	<b>114-117</b>
<b>Textiles</b>	<b>118-133</b>
<b>Interiors</b>	<b>134-149</b>
<b>Safety and Essentials</b>	<b>150-154</b>
<b>Reference Guide</b>	<b>155-169</b>

# Paper Supplies



# Paper Products

## Standard Facial Tissues

- Available in three different box sizes to suit your needs
- Boxes come with inspirational, uplifting designs

Item No.	Description	Pkg.
NON243277	Large Box, 2-Ply, Tree Print	90 sheets/bx, 30 bx/cs
NON243276	Medium box, 2-Ply, Leaf Print	60 sheets/bx, 72 bx/cs
NON243275	Small box, 2-Ply, Circle Print	40 sheets/bx, 200 bx/cs



NON243275

## Premium Facial Tissues

- Our softest, strongest and most absorbent tissue
- Boxes come in stylish designs for a feels-like-home environment
- Shields help repel dust particles

Item No.	Description	Pkg.
NON245277	Flat Box, Premium 2-Ply	100 sheets/bx, 36 bx/cs
NON245276	Medium, Premium 2-Ply	60 sheets/bx, 48 bx/cs
NON245278	8" x 8.3" Cube Box, 2-Ply	85 sheets/pk, 36 bx/cs
NON245273	Pocket Pack, 3-Ply	10 sheets/pk, 100 bx/cs



NON245277

## Toilet Seat Cover

- Helps ensure a cleaner bathroom environment
- Dispensed easily

Item No.	Description	Pkg.
NON26899	Half Fold Toilet Seat Cover, Refill	250/pk, 20 pk/cs, 5,000/cs



NON26899

## Toilet Tissues

- Soft and affordable to help improve patient experience and your bottom line

Item No.	Description	Pkg.
NON26801	Standard, 1-Ply, 4.5" x 3.8" Sheet	1,000 sheets/roll, 96 rolls/cs
NON26800	Standard, 2-ply, 4.5" x 3.8" Sheet	500 sheets/roll, 96 rolls/cs
NON27800	Standard, 2-Ply, 4" x 4" Sheet	500 sheets/roll, 96 rolls/cs
NON28800	Deluxe, 2-Ply, 4.5" x 3.25" Sheet	400 sheets/roll, 96 rolls/cs
NON26805	Standard Jumbo, 3.8" x 1,000' Roll	8 rolls/cs
NON28805	Deluxe Jumbo, 3.8" x 650' Roll	12 rolls/cs
NON28830*	Small Core, 2-Ply, 3.85" x 4.05" Sheet	750 sheets/roll, 36 rolls/cs



NON27800

\*Fits most small core and coreless dispensers.

# Paper Products

## Single-Fold Towels

- One side of the towel is folded once
- Requires a larger dispenser than multi-fold or C-fold towels

Item No.	Description	Sheet Size	Pkg.
EVSSINGLEFB	White, 1-Ply	10.25" x 8.62"	334/pk, 12 pk/cs, 4,008/cs
EVSSINGLEFN	Natural, 1-Ply	10.25" x 8.62"	334/pk, 12 pk/cs, 4,008/cs



EVSSINGLEFN

EVSSINGLEFB

## Perforated Roll Towel

- Standard household roll towel
- Ready for any job

Item No.	Description	Sheet Size	Pkg.
NON26835	White, 2-Ply	8.8" x 11"	85 sheets/roll, 30 rolls/cs



NON26835

## Z-Fold Towels

- Folded into the next towel for automatic feeding
- Deluxe option features a heavier paper

Item No.	Description	Sheet Size	Pkg.
NON25815	Standard, Natural	9.13" x 9.5"	250/pk, 16 pk/cs, 4,000/cs
NON26810	Standard, White	9.13" x 9.5"	250/pk, 16 pk/cs, 4,000/cs
NON26812	Standard, White	9.25" x 7.7"	250/pk, 16 pk/cs, 4,000/cs
NON26813	Deluxe, White	9.13" x 9.5"	250/pk, 16 pk/cs, 4,000/cs
NON26818	Premium, TAD, White	8.75" x 9.5"	200/pk, 12/cs, 2,400/cs



NON26810

## C-Fold Towel

- Both sides of the towel are folded inward
- Stacked individually

Item No.	Description	Sheet Size	Pkg.
NON26821	White, 1-ply	13" x 10"	200/pk, 12 pk/cs, 2,400/cs



NON26821

# Paper Products

## Roll Towels

- An economical choice
- Center-pull design to help reduce cross-contamination
- Deluxe option with thicker, fluffier paper

Item No.	Description	Color	Sheet Size	Pkg.
NON26830	Center-Pull	White	600 sheets/roll, 8.25" x 12"	6 rolls/cs
NON26836	Center-Pull	White	330 sheets/roll, 7.6" x 11"	6 rolls/cs
NONPBM350	Standard	White	8" x 350'	12 rolls/cs
NON25825	Standard	Natural	8" x 350'	12 rolls/cs
NONPBM800B	Standard	White	8" x 800'	6 rolls/cs
NONPBM800N	Standard	Natural	8" x 800'	6 rolls/cs
NON288425	Deluxe	White	8" x 425'	6 rolls/cs
NON26872	Standard	White	10" x 800'	6 rolls/cs
NON26870	Deluxe	White	10" x 425'	6 rolls/cs



NON25825

NONPBM350

## Napkins

- An economical choice for your facilities
- Ideal for high-volume applications

Item No.	Description	Pkg.
NONPLT257DN	Dinner Napkin, 15" x 17", White	3,000/cs
NON25803	Beverage Napkin, White	4,000/cs
NON25806	Dinner Napkin, Square, White	4,008/cs
NON25807	Lunch Napkin, 12" x 12", White	6,000/cs



NON25807

### A Versatile Clean

You can rely on the strength and durability of Medline paper products to help you tackle any cleanup. From small to large messes and everything in between, our paper towels, toilet paper and facial tissue answer the call, no matter the task at hand. All our paper products are soft to the touch and strong enough to stand up to your toughest cleaning needs.



**Ready to roll?** Contact your Medline Representative to learn more.

# Paper Towel Dispensers



EVSDWAUTO100

EVSDWAUTO102



EVSDWMECH100

EVSDWMECH102



PAXTD023501

PAXTD023503



EVSDSRMECH2

## Auto Roll Towel Dispensers

- Compatible paper product: NON25825, NONPBM350, NONPBM800N, NONPBM800B, NON288425
- Each dispenser requires 4 D-cell batteries

Item No.	Description	Color	Pkg.
EVSDWAUTO100	9.7"D x 12.3"W x 16.8"H	Black	1 ea
EVSDWAUTO102	9.7"D x 12.3"W x 16.8"H	White	1 ea
PAXTD023501	8.58"D x 11.39"W x 13.21"H	Black	1 ea
PAXTD023503	8.58"D x 11.39"W x 13.21"H	White	1 ea

## Mechanical Roll Towel Dispensers

- Compatible paper products: NON25825, NONPBM350, NONPBM800N, NONPBM800B, NON288425
- Dispensers do not require batteries

Item No.	Description	Color	Pkg.
EVSDWMECH100	9.7"D x 12.3"W x 16.8"H	Black	1 ea
EVSDWMECH102	9.7"D x 12.3"W x 16.8"H	White	1 ea
EVSDSRMECH2	8.98"D x 11.43"W x 15.02"H	Black	1 ea

# Paper Towel Dispensers

## Multifold Towel Dispensers

- Compatible paper products: NON25815, NON26810, NON26813, NON26818

Item No.	Description	Color	Pkg.
EVSDWMF100	5.34"D x 11.76"W x 15.89"H	Black	1 ea
EVSDWMF102	5.34"D x 11.76"W x 15.89"H	White	1 ea
EVSDSMFB	11.5"H x 11.5"W x 6"D	Black	1 ea
EVSDSMFB2	11.5"H x 11.5"W x 6"D	Black	1 ea
EVSDSMFW	11.5"H x 11.5"W x 6"D	White	1 ea
EVSDSMFB2S	11"H x 10.8"W x 4.5"D	Black	1 ea
EVSDSMFWS	11"H x 10.8"W x 4.5"D	White	1 ea



EVSDWMF100

EVSDWMF102



EVSDSMFB



EVSDSMFB2

EVSDSMFW



PAXTD0175BK



EVSDSMCOUNTER

## C-Fold and Multi-Fold Towel Dispensers

- Compatible paper products: NON26810, NON26813, NON25815, NON26818, NON26821

Item No.	Description	Color	Pkg.
PAXTD0175BK	15.25"H x 11.375"W x 5"D	Black	1 ea
PAXTD0175WH	15.25"H x 11.375"W x 5"D	White	1 ea

## Countertop Multifold Towel Dispenser

- Compatible paper products: NON25815, NON26810, NON26813, NON26818, NON26821

Item No.	Description	Color	Pkg.
EVSDSMCOUNTER	4.375"D x 11"W x 7"H	Black	1 ea

# Paper Towel Dispensers



EVDSRCENTERP



EVSDWCTRP100

EVSDWCTRP102

## Center-Pull Towel Dispensers

- Dispenses single sheets for reliable portion control
- Touchless center-pull design to help prevent cross-contamination
- Large capacity for long intervals between refills
- Helps reduce maintenance costs and provides a hygienic hand-drying environment
- Compatible paper products: NON26830, NON26836

Item No.	Description	Color	Pkg.
EVDSRCENTERP	11.63"H x 9.13"W x 9.5"D	Black	1 ea
EVSDWCTRP100	10.12"D x 10"W x 12.4"H	Black	1 ea
EVSDWCTRP102	10.12"D x 10"W x 12.4"H	White	1 ea

# Toilet Seat Cover Dispenser

## Toilet Seat Cover Dispenser

- Compatible paper product: NON26899

Item No.	Description	Color	Pkg.
EVSDSCOVER2	Half Fold, 3.125"D x 17.25"W x 11.75"H	Black	2/cs



EVSDSCOVER2

# Toilet Paper Dispensers



## Double-Roll Small Core Toilet Paper Dispensers

- Compatible paper product: NON28830

Item No.	Description	Color	Pkg.
EVSDWSMCR100	5.25"D x 13.5"W x 8"H	Black	1 ea
EVSDWSMCR102	5.25"D x 13.5"W x 8"H	White	1 ea
EVSDSTPSMC	5.48"D x 11.86"W x 7.32"H	Black	1 ea

## Double-Roll Standard Core Toilet Paper Dispensers

- Compatible paper products: NON26800, NON27800, NON28800

Item No.	Description	Color	Pkg.
EVSDWSTCOR100	5.25"D x 13.5"W x 8"H	Black	1 ea
EVSDWSTCOR102	5.25"D x 13.5"W x 8"H	White	1 ea
EVSDSTPVSTD	Vertical, 6.16"D x 6.02"W x 13.04"H	Black	1 ea
EVSDSTPHSTD	Horizontal, 5.48"D x 11.86"W x 7.32"H	Black	1 ea



## Single- and Double-Roll Jumbo Toilet Paper Dispensers

- Compatible paper product: NON26805, NON28805

Item No.	Description	Color	Pkg.
EVSDWJMBS100	Single-Roll, 5.57"D x 11.5"W x 11.55"H	Black	1 ea
EVSDWJMBS102	Single-Roll, 5.57"D x 11.5"W x 11.55"H	White	1 ea
EVSDSTP91	Single-Roll, 5.37"D x 11.47"W x 11.2"H	Black	1 ea
EVSDWJMBD100	Double-Roll, 5.62"D x 21.2"W x 11.4"H	Black	1 ea
EVSDWJMBD102	Double-Roll, 5.62"D x 21.2"W x 11.4"H	White	1 ea
EVSDSTP92	Double-Roll, 5.37"D x 20.23"W x 11.71"H	White	1 ea

# Liners, Hampers and Trash Cans



# How to choose the right bag

What's the difference between a low-density and high-density liners?



VS.



## Low Density

- Think “trash liners at home”
- Measured in mils
- Superior stretch for heavier items
- Waste type: heavy waste (i.e. linens, food, waste and sharp objects)

## High Density

- Think “plastic grocery store bags”
- Measured in microns (mics)
- Less material so it's less expensive
- Waste type: soft waste (i.e. tissue paper, paper towels and heavy, not sharp waste)

## Helpful hints on selecting can liners

To convert mil to microns, multiply the mil by 25.4 to arrive at true micron thickness.

## How to measure for correct can liner size

**Bag width:** Half the outer circumference of the container.

**Bag length:** For round containers, use the height of the container, plus half of the diameter of the bottom, plus 3" (for overhang).

For square or rectangular containers, use the diagonal of the container bottom, rather than the diameter.

Types of waste	Thickness (mil)						
	Low density high mil	Low density med mil	Low density low mil	High density high mic	High density med mic	High density low-med mic	High density low mic
Heavy sharp objects	●						
Average weight sharps, broken glass		●					
Lightweight waste with sharp corners			●				
Rough cafeteria waste, sharp objects		●	●				
General food waste			●	●			
Heavy paper (i.e., newspaper, magazines)				●			
Terries, linens, microfiber				●	●		
General mixed restroom waste						●	
Tissue paper							●

Thickness (mil)	Approximate micron Equivalent
0.23	6
0.27	7
0.31	8
0.35	9
0.39	10
0.43	11
0.47	12
0.51	13
0.55	14
0.59	15
0.62	16
0.66	17
0.70	18
0.74	19
0.78	20
0.82	21
0.86	22
0.90	23
0.94	24
0.98	25

# Standard Trash Liners

## Low Density—Clear and Black

- Superior stretch and tear resistance
- Ideal for heavy or sharp waste
- Choose from Clear or Black in a wide range of sizes and thickness

Item No.	Size	Color	Thickness	Style	Pkg.
<b>7–10 Gal Capacity</b>					
NON022205C	20" x 21"	Clear	0.35 mil	Flat	1,000/cs
NON022207	24" x 23"	Clear	0.35 mil	Flat	500/cs
NON022208	24" x 23"	Black	0.35 mil	Flat	500/cs
NONCRC23H	24" x 23"	Clear	0.6 mil	Roll	500/cs
<b>12–16 Gal Capacity</b>					
NONCRB32RL	24" x 32"	Black	0.35 mil	Roll	1,000/cs
NON022210	24" x 32"	Black	0.35 mil	Flat	500/cs
NONCXC32H	24" x 32"	Clear	0.6 mil	Flat	500/cs
NONTGG32	24" x 32"	Black	1 mil	Flat	250/cs
NONCRPXC32	24" x 32"	Clear	1 mil	Roll	250/cs
<b>20–30 Gal Capacity</b>					
NON135332C	18" x 33"	Clear	2 mil	Flat	250/cs
NONCXC36H	30" x 36"	Clear	0.6 mil	Flat	250/cs
NONCXB36H	30" x 36"	Black	0.6 mil	Flat	250/cs
NONPXC36X	30" x 36"	Clear	1 mil	Flat	250/cs
<b>33-Gal Capacity</b>					
NON022225	33" x 39"	Black	0.45 mil	Flat	250/cs
NONPXC39XRL	33" x 40"	Clear	1 mil	Roll	250/cs
NONPXC39X	33" x 40"	Clear	1 mil	Flat	250/cs
NONTGG39XH	33" x 40"	Black	1.35 mil	Flat	100/cs
NON023542	35" x 42"	Clear	0.8 mil	Roll	250/cs
<b>40–45 Gal Capacity</b>					
IRC3845P	38" x 45"	Clear	2 mil	Roll	100/cs
NON022231	40" x 46"	Black	0.65 mil	Flat	125/cs
NONCRPXC46C	40" x 46"	Clear	1 mil	Roll	125/cs
NONCRPXC46XXH	40" x 46"	Clear	1.8 mil	Roll	100/cs
NONTGG46XXHRL	40" x 46"	Black	1.8 mil	Roll	100/cs
NONTGG46XXH	40" x 46"	Black	1.8 mil	Flat	100/cs
NON022237	40" x 46"	Clear	2 mil	Flat	100/cs
<b>55–60 Gal Capacity</b>					
NONTGG58XRL	38" x 58"	Black	1 mil	Roll	100/cs
NONTGG58X	38" x 58"	Black	1 mil	Flat	100/cs
NONTGG58XHR	38" x 58"	Black	1.35 mil	Roll	100/cs
NONTGG58XH	38" x 58"	Black	1.35 mil	Flat	100/cs
NONPXC58XH	38" x 58"	Clear	1.35 mil	Flat	100/cs
NON022245C	36" x 58"	Clear	0.65 mil	Flat	100/cs
NONPXC57X	37" x 57"	Clear	1.1 mil	Flat	100/cs
NONTGG55XXH	40" x 55"	Black	1.8 mil	Flat	100/cs
NONTGG47HPRL	43" x 47"	Black	1.2 mil	Roll	100/cs
NONPXC47XH	43" x 47"	Clear	1.35 mil	Flat	100/cs
NONPXC47XXH	43" x 47"	Clear	1.8 mil	Flat	100/cs
NONTGG47XXHRL	43" x 47"	Black	1.8 mil	Roll	100/cs
NONTGG47XXH	43" x 47"	Black	1.8 mil	Flat	100/cs
<b>96-Gal Capacity</b>					
NONCRB96GAL	52" x 76"	Black	1.8 mil	Roll	50/cs



## High Density—Clear and Black

- A great choice for soft trash (typical office, restroom, paper, etc.)
- Strong while offering a cost savings over traditional low-density products

Item No.	Size	Color	Thickness	Style	Pkg.
<b>7–10 Gal Capacity</b>					
NON2022	20" x 22"	Clear	6 mic	Roll	2000/cs
NONHCR24LB	24" x 24"	Black	6 mic	Roll	1,000/cs
NONHCR24LC	24" x 24"	Clear	6 mic	Roll	1,000/cs
NONCHD24MC	24" x 24"	Clear	8 mic	Flat	1,000/cs
NONHCR24MC	24" x 24"	Clear	8 mic	Roll	1,000/cs
NONHCR24MB	24" x 24"	Black	8 mic	Roll	1,000/cs
NONHCR2410C	24" x 24"	Clear	10 mic	Roll	1,000/cs
<b>12–16 Gal Capacity</b>					
NONCHD33LC	24" x 33"	Clear	6 mic	Flat	1,000/cs
NONHCR33MB	24" x 33"	Black	8 mic	Roll	1,000/cs
NONHCR33MC	24" x 33"	Clear	8 mic	Roll	1,000/cs
NONHCR243311	24" x 33"	Clear	11 mic	Roll	500/cs
NONHCR243311B	24" x 33"	Black	11 mic	Roll	500/cs
<b>20–30 Gal Capacity</b>					
IRH2945E	29" x 45"	Clear	14 mic	Roll	250/cs
NONHCR37MC	30" x 37"	Clear	8 mic	Roll	500/cs
NONCHD37MC	30" x 37"	Clear	8 mic	Flat	500/cs
NONHCR3710C	30" x 37"	Clear	10 mic	Roll	500/cs
NONHCR37HC	30" x 37"	Clear	12 mic	Roll	500/cs
NONHCR37XB	30" x 37"	Black	16 mic	Roll	500/cs
<b>33-Gal Capacity</b>					
NONHCR40MB	33" x 40"	Black	10 mic	Roll	500/cs
NONHCR40HC	33" x 40"	Clear	12 mic	Roll	500/cs
NONHCR40XC	33" x 40"	Clear	16 mic	Roll	250/cs
NON334019B	33" x 40"	Black	19 mic	Roll	250/cs
NONCHD40STC	33" x 40"	Clear	22 mic	Flat	250/cs
<b>40–45 Gal Capacity</b>					
NONHCR48HC	40" x 48"	Clear	13 mic	Roll	250/cs
NONHCR48HB	40" x 48"	Black	13 mic	Roll	250/cs
NONHCR48XC	40" x 48"	Clear	16 mic	Roll	250/cs
NONHCR48XB	40" x 48"	Black	16 mic	Roll	250/cs
NONHCR48STB	40" x 48"	Black	22 mic	Roll	150/cs
<b>55–60 Gal Capacity</b>					
NONCHD60HC	36" x 58"	Clear	13 mic	Flat	200/cs
NONHCR62XC	38" x 58"	Clear	17 mic	Roll	200/cs
NONCHD62XC	38" x 58"	Clear	17 mic	Flat	200/cs
NONCHD47HC	43" x 48"	Clear	14 mic	Flat	200/cs
NONHCR47STB	43" x 48"	Black	22 mic	Roll	150/cs

# Blend Right Trash Liners

## Low Density—Clear and Black

- Composed of a mixture of several types of resin to offer a more cost-effective solution
- Ideal for heavy or sharp waste

Item No.	Size	Color	Thickness	Style	Pkg.
<b>12–16 Gal Capacity</b>					
EVSBL243235CF	24" x 32"	Clear	0.35 mil	Flat	1,000/cs
EVSBL243235C	24" x 32"	Clear	0.35 mil	Roll	1,000/cs
EVSPC24327C	24" x 32"	Clear	0.7 mil	Roll	500/cs
EVSBL24327BK	24" x 32"	Black	0.7 mil	Roll	500/cs
EVSPC24327BK	24" x 32"	Black	0.7 mil	Roll	500/cs
EVSBL24327C	24" x 32"	Clear	0.7 mil	Roll	500/cs
EVSBL24329BK	24" x 32"	Black	0.9 mil	Roll	500/cs
<b>20–30 Gal Capacity</b>					
EVSBL303645CF	30" x 36"	Clear	0.45 mil	Flat	250/cs
EVSBL30365BK	30" x 36"	Black	0.65 mil	Roll	250/cs
EVSBL303665C	30" x 36"	Clear	0.65 mil	Roll	250/cs
<b>33-Gal Capacity</b>					
EVSBL333965C	33" x 39"	Clear	0.65 mil	Roll	250/cs
EVSBL333965CF	33" x 39"	Clear	0.65 mil	Flat	250/cs
EVSBL33399C	33" x 39"	Clear	0.9 mil	Roll	150/cs
EVSBL333995KF	33" x 39"	Black	0.9 mil	Flat	100/cs
EVSBL333995BK	33" x 39"	Black	0.95 mil	Roll	100/cs
EVSBL33459C	33" x 45"	Clear	0.9 mil	Roll	200/cs
<b>40–45 Gal Capacity</b>					
EVSBL40467C	40" x 46"	Clear	0.7 mil	Roll	125/cs
EVSBL40467CFT	40" x 46"	Clear	0.7 mil	Flat	125/cs
EVSBL40469C	40" x 46"	Clear	0.9 mil	Roll	100/cs
EVSBL40469BK	40" x 46"	Black	0.9 mil	Roll	100/cs
EVSPC404695C	40" x 46"	Clear	0.95 mil	Roll	125/cs
EVSBL404611C	40" x 46"	Clear	1.1 mil	Roll	125/cs
EVSBL404611CF	40" x 46"	Clear	1.1 mil	Flat	125/cs
EVSBL404615BK	40" x 46"	Black	1.5 mil	Roll	250/cs
EVSBL404615KF	40" x 46"	Black	1.5 mil	Flat	250/cs
EVSBL404615C	40" x 46"	Clear	1.5 mil	Roll	100/cs
EVSBL404615CF	40" x 46"	Clear	1.5 mil	Flat	100/cs
<b>55–60 Gal Capacity</b>					
EVSBL38589C	38" x 58"	Clear	0.9 mil	Roll	100/cs
EVSBL385813C	38" x 58"	Clear	1.3 mil	Roll	100/cs
EVSBL385815BK	38" x 58"	Black	1.5 mil	Roll	100/cs
EVSBL38582BK	38" x 58"	Black	2 mil	Roll	100/cs
EVSA386015B	38" x 60"	Black	1.5 mil	Flat	100/cs
EVSBL4347115C	43" x 47"	Clear	1.15 mil	Roll	100/cs



## High Density—Clear and Black

- Composed of a mixture of several types of resin to offer a more cost effective solution
- Great for soft trash (typical office, restroom, paper, etc.)

Item No.	Size	Color	Thickness	Style	Pkg.
<b>12–15 Gal Capacity</b>					
EVSBH24276N	24" x 27"	Clear	6 mic	Roll	1,000/cs
EVSBH24276NFT	24" x 27"	Clear	6 mic	Flat	1,000/cs
EVSBH243014N	24" x 30"	Clear	14 mic	Roll	500/cs
EVSBH24338N	24" x 33"	Clear	8 mic	Roll	1,000/cs
EVSBH24338NFT	24" x 33"	Clear	8 mic	Flat	1,000/cs
<b>20–30 Gal Capacity</b>					
EVSBH30378N	30" x 37"	Clear	8 mic	Roll	500/cs
EVSBH303710N	30" x 37"	Clear	10 mic	Roll	500/cs
EVSBH303710NF	30" x 37"	Clear	10 mic	Flat	500/cs
EVSBH303712N	30" x 37"	Clear	12 mic	Roll	500/cs
EVSBH303712NF	30" x 37"	Clear	12 mic	Flat	500/cs
EVSBH303714BK	30" x 37"	Black	14 mic	Roll	500/cs
EVSBH303716N	30" x 37"	Clear	16 mic	Roll	500/cs
EVSBH303716NF	30" x 37"	Clear	16 mic	Flat	500/cs
<b>33-Gal Capacity</b>					
EVSBH334010N	33" x 40"	Clear	10 mic	Roll	500/cs
EVSBH334012N	33" x 40"	Clear	12 mic	Roll	500/cs
EVSBH334012NF	33" x 40"	Clear	12 mic	Flat	500/cs
EVSBH334016NF	33" x 40"	Clear	16 mic	Flat	250/cs
EVSBH334011NF	33" x 40"	Clear	11 mic	Roll	500/cs
EVSBH334017N	33" x 40"	Clear	17 mic	Roll	250/cs
<b>40–45 Gal Capacity</b>					
EVSBH404813N	40" x 48"	Clear	13 mic	Roll	250/cs
EVSBH404813NF	40" x 48"	Clear	13 mic	Flat	250/cs
EVSBH404816N	40" x 48"	Clear	16 mic	Roll	250/cs
EVSBH404816NF	40" x 48"	Clear	16 mic	Flat	250/cs
EVSBH404822N	40" x 48"	Clear	22 mic	Roll	150/cs
EVSBH404822NF	40" x 48"	Clear	22 mic	Flat	150/cs
EVSBH404817N	40" x 48"	Clear	17 mic	Roll	250/cs
EVSBH404819N	40" x 48"	Clear	19 mic	Roll	200/cs
<b>55–60 Gal Capacity</b>					
EVSBH434812N	43" x 48"	Clear	12 mic	Roll	200/cs
EVSBH434817N	43" x 48"	Clear	17 mic	Roll	200/cs
EVSBH365813C	36" x 58"	Clear	13 mic	Roll	200/cs
EVSBH374614N	37" x 46"	Clear	14 mic	Roll	250/cs
EVSBH385817BK	38" x 58"	Black	17 mic	Roll	200/cs
EVSBH386022N	38" x 60"	Clear	22 mic	Flat	150/cs
EVSBH386022NF	38" x 60"	Clear	22 mic	Roll	150/cs

# Colored Trash Liners

## Standard Colored Trash Liners

- Composed of virgin resin which outperforms blended and recycled counterparts
- Identify different types of waste, recyclables and production materials with colored trash liners

Item No.	Size	Color	Thickness	Style	Pkg.
<b>7-10 Gal Capacity</b>					
NON022250	20" x 22"	White	1.0 mil	Flat	500/cs
<b>12-16 Gal Capacity</b>					
IRBR32HI	24" x 32"	Brown	0.8 mil	Roll	500/cs
<b>20-30 Gal Capacity</b>					
NON26383B	26" x 38"	Dark Blue	3.0 mil	Flat	125/cs
NON28449GN	28" x 44"	Green	0.9 mil	Roll	250/cs
NONXPW36X	30" x 36"	White	0.8 mil	Roll	200/cs
NON303616ORN	30" x 36"	Orange	1.6 mil	Roll	200/cs
<b>33-Gal Capacity</b>					
IRG2943H	29" x 43"	Mint Green	0.7 mil	Roll	240/cs
IRGL43C	29" x 43"	Green	1.0 mil	Roll	240/cs
NON314314BNP	31" x 43"	Blue	14 mic	Roll	400/cs
NON3345XW	33" x 45"	White	1.4 mil	Roll	100/cs
<b>40-45 Gal Capacity</b>					
IW3648N	36" x 48"	White	1.6 mil	Flat	100/cs
RH3746EG	37" x 46"	Mint Green	14 mic	Roll	250/cs
IRMG3845D	38" x 45"	Mint Green	1.25 mil	Roll	150/cs
YL4045E	39.5" x 45"	Yellow	1.17 mil	Flat	125/cs
NON022246	40" x 46"	Blue	0.7 mil	Roll	250/cs
NON404816ORN	40" x 48"	Orange	1.6 mil	Roll	100/cs
NON404814G	40" x 48"	Green	14 mic	Flat	250/cs
<b>55-60 Gal Capacity</b>					
NONCRW47X	43" x 47"	White	0.75 mil	Roll	100/cs
IGY6448P	64" x 48"	Gray	2.0 mil	Roll	50/cs

## Drawtape Colored Trash Liners

- Convenient drawtape closure

Item No.	Size	Color	Thickness	Style	Pkg.
<b>20-30 Gal Capacity</b>					
LB2938E	29" x 38"	Light Blue	1.5 mil	Roll	150/cs
NON022939WH	29" x 41"	White	1.1 mil	Roll	200/cs



NON26383B

## Blend Right Colored Trash Liners

- Composed of a mixture of several types of resin to offer a more cost-effective solution
- Trash bag with a color that stands out helps you clearly identify its contents at a glance

Item No.	Size	Color	Thickness	Style	Pkg.
<b>12-15 Gal Capacity</b>					
EVSPC243245W	24" x 32"	White	0.45 mil	Roll	500/cs
EVSBL24327W	24" x 32"	White	0.7 mil	Roll	500/cs
<b>33-Gal Capacity</b>					
EVSBL33391W	33" x 39"	White	1.0 mil	Roll	250/cs
NON022939WH	29" x 41"	White	1.1 mil	Roll	200/cs
<b>40-45 Gal Capacity</b>					
EVSBL404611G	40" x 46"	Gray	1.1 mil	Roll	125/cs
EVSPC404611G	40" x 46"	Gray	1.1 mil	Roll	125/cs
EVSBL404613B	40" x 46"	Blue	1.3 mil	Roll	200/cs
EVSBL40461W	40" x 46"	White	1.0 mil	Roll	125/cs
EVSBL404817B	40" x 48"	Blue	17 mic	Roll	250/cs
<b>55-60 Gal Capacity</b>					
EVSBL385895W	38" x 58"	White	0.95 mil	Roll	100/cs
EVSBL4254811G	42.5" x 48"	Gray	1.1 mil	Roll	100/cs

# Biohazard Liners



NON153143



EVSBL404613RP



NON024048

## Standard Biohazard Liners

- Composed of virgin resin which outperforms blended and recycled counterparts

Item No.	Size	Color	Thickness	Style	Pkg.
<b>2-Gal Capacity</b>					
NON151212	12" x 12"	Red	2 mil	Flat, Zip Closure	1,000/cs
<b>4-Gal Capacity</b>					
NON151717	17" x 17"	Red	1.5 mil	Flat	500/cs
<b>10-Gal Capacity</b>					
NON122424	24" x 24"	Red	1.2 mil	Flat	500/cs
NONHDR24RL	24" x 24"	Red	13 mic	Roll	1,000/cs
NONHDR24	24" x 24"	Red	13 mic	Flat	1,000/cs
NON152426	24" x 26"	Red	1.5 mil	Flat	200/cs
NONHDR33	24" x 33"	Red	11 mic	Roll	500/cs
<b>33-Gal Capacity</b>					
NONHDR43	30.5" x 43"	Red	14 mic	Roll	250/cs
NON153143	31" x 43"	Red	1.5 mil	Flat	250/cs
NON203143	31" x 43"	Red	2 mil	Flat	100/cs
NON303143	31" x 43"	Red	3 mil	Flat	100/cs
<b>45-55 Gal Capacity</b>					
NON154046	40" x 46"	Red	1.5 mil	Flat	100/cs
NONHDR48	40" x 48"	Red	17 mic	Roll	250/cs
NON304055	40" x 55"	Red	3 mil	Flat	50/cs

## Blend Right Bag Biohazard Liners

- Composed of a mixture of several types of resin to offer a more cost-effective solution

Item No.	Size	Color	Thickness	Style	Pkg.
<b>7-10 Gal Capacity</b>					
EVSBL242412RP	24" x 24"	Red	1.2 mil	Roll	500/cs
EVSBL243212RP	24" x 32"	Red	1.2 mil	Roll	500/cs
<b>20-25 Gal Capacity</b>					
EVSBL304313RP	30" x 43"	Red	1.3 mil	Roll	200/cs
<b>30-35 Gal Capacity</b>					
EVSBL333912RP	33" x 39"	Red	1.2 mil	Roll	150/cs
<b>40-50 Gal Capacity</b>					
EVSBL375013RP	37" x 50"	Red	1.3 mil	Roll	150/cs
EVSBL404613RP	40" x 46"	Red	1.3 mil	Roll	200/cs
EVSBL40462RPF	40" x 46"	Red	2 mil	Flat	100/cs
EVSBL40462RP	40" x 46"	Red	2 mil	Roll	100/cs
EVSBL40463RP	40" x 46"	Red	3 mil	Roll	75/cs
EVSBL40463RPF	40" x 46"	Red	3 mil	Flat	75/cs

## Yellow Infectious Linen Liners

- Color-coding, biohazard symbols and bilingual markings help keep materials safely separated

Item No.	Size	Color	Thickness	Style	Pkg.
NONHDY304314	30.5 x 43	Yellow	14 mic	Roll	250/cs
NON024042	31 x 43	Yellow	1.2 mil	Roll	100/cs
NON024046RL	40 x 46	Yellow	1.5 mil	Roll	100/cs
NON024046	40 x 46	Yellow	1.5 mil	Flat	100/cs

# Soiled Linen Liners

## Standard Soiled Linen Liners

- Printed with "Soiled Linen" in English and Spanish
- Composed of virgin resin which outperforms blended and recycled counterparts

Item No.	Size	Color	Thickness	Style	Pkg.
<b>20-30 Gal Capacity</b>					
IRDPL33C	29" x 33"	Pink	1 mil	Roll	240/cs
IHBL33FF	29" x 33"	Blue	14 mic	Roll	250/cs
IRHBL38E	29" x 38"	Blue	14 mic	Roll	250/cs
IHBL38F	29" x 38"	Blue	16 mic	Roll	250/cs
NON293817BP	29" x 38"	Blue	17 mic	Roll	250/cs
IRDBL38C	29" x 38"	Blue	1 mil	Roll	240/cs
NON303214W	30" x 33"	White	1.4 mil	Roll	250/cs
<b>33-Gal Capacity</b>					
IRDPL33C	29" x 33"	Pink	1 mil	Roll	240/cs
IHBL33FF	29" x 33"	Blue	14 mic	Roll	250/cs
IRHBL38E	29" x 38"	Blue	14 mic	Roll	250/cs
IHBL38F	29" x 38"	Blue	16 mic	Roll	250/cs
NON293817BP	29" x 38"	Blue	17 mic	Roll	250/cs
IRDBL38C	29" x 38"	Blue	1 mil	Roll	240/cs
NON023143P	29" x 43"	Purple	1.1 mil	Roll	200/cs
NON294311MG	29" x 43"	Mint Green	1.1 mil	Roll	200/cs
NON023143	29" x 43"	Blue	1.1 mil	Roll	200/cs
NON202943B	29" x 43"	Blue	2 mil	Roll	100/cs
IHWL43F	29" x 43"	White	16 mic	Roll	250/cs
IRDPL45C	29" x 45"	Pink	1 mil	Roll	240/cs
IRDWL45C	29" x 45"	White	1 mil	Roll	240/cs
IRDBL45C	29" x 45"	Blue	1 mil	Roll	240/cs
IRDPR45C	29" x 45"	Purple	1 mil	Roll	240/cs
IRDOR45C	29" x 45"	Orange	1 mil	Roll	240/cs
NONHDB43	31" x 43"	Blue	17 mic	Roll	250/cs
IRHBL45F	35" x 45"	Blue	17 mic	Roll	250/cs
<b>55-60 Gal Capacity</b>					
NON02221658	38" x 58"	Blue	1.5 mil	Flat	100/cs

## Blend Right Bag Soiled Linen Liners

- Printed with "Soiled Linen" in English and Spanish
- Composed of a mixture of several types of resin to offer a more cost-effective solution

Item No.	Size	Color	Thickness	Style	Pkg.
EVSA30401LB2	30" x 40"	Light Blue	1 mil	Roll	200/cs
EVSBH304314BP	30" x 43"	Blue	14 mic	Roll	250/cs
EVSBH304519BP	30" x 45"	Blue	19 mic	Roll	250/cs
EVSBL375013BP	37" x 50"	Blue	1.3 mil	Roll	150/cs
EVSBL375013BF	37" x 50"	Blue	1.3 mil	Flat	150/cs
EVSA38441DB	38" x 44"	Blue	1 mil	Roll	200/cs
EVSBH404814BP	40" x 48"	Blue	14 mic	Roll	250/cs
EVSBH404818BP	40" x 48"	Blue	18 mic	Roll	200/cs



EVSBH404818BP

NON023143

## Drawtape Soiled Linen Liners

- Printed with "Soiled Linen" in English and Spanish

Item No.	Size	Color	Thickness	Style	Pkg.
<b>20-30 Gal Capacity</b>					
LW2933C	30" x 33"	White	0.9 mil	Roll	150/cs
LB2933C	30" x 33"	Blue	0.9 mil	Roll	150/cs
<b>30-Gal Capacity</b>					
LB2938C1	29" x 38"	Light Blue	0.79 mil	Roll	150/cs
LB2938C	29" x 38"	Blue	0.9 mil	Roll	150/cs
LW2938D	29" x 38"	White	1.1 mil	Roll	150/cs
LB2938D	29" x 38"	Blue	1.1 mil	Roll	150/cs
LG2938D	29" x 38"	Mint Green	1.2 mil	Roll	200/cs
LB2938SP	29" x 38"	Blue	1.5 mil	Roll	150/cs
<b>32-Gal Capacity</b>					
EVSAGBD2901	29" x 41"	Blue	1 mil	Roll	200/cs
EVSAGBD2915	29" x 41"	Blue	1.5 mil	Roll	150/cs
EVSAGGD2902	29" x 41"	Green	2 mil	Roll	100/cs
EVSAGWD2902	29" x 41"	White	2 mil	Roll	100/cs
EVSAGBD2902	29" x 41"	Blue	2 mil	Roll	100/cs
EVSAGGRN	29" x 43"	Mint Green	1 mil	Roll	200/cs
EVSAGBLUE	29" x 43"	Blue	1 mil	Roll	200/cs

# Soiled Linen Liners

## Peerless Soiled Linen Liners

- Made with prime virgin resin—the highest quality material in the industry
- Designed to hold manageable loads effectively
- Fits carts/hampers perfectly and great for laundry chutes
- Superior strength, yet tear open easily for sorting with no need for heavy overhead lifting—sorting can be done very quickly and efficiently

Item No.	Size	Color	Thickness	Style	Pkg.
<b>20–30 Gal Capacity</b>					
RDB2543B	25" x 43"	Light Blue	0.9 mil	Roll	250/cs
RDWL33B	29" x 33"	White	0.79 mil	Roll	240/cs
RDBL33B	29" x 33"	Blue	0.79 mil	Roll	240/cs
RDBL38A	29" x 38"	Light Blue	0.54 mil	Roll	240/cs
RDYL38B	29" x 38"	Yellow	0.79 mil	Roll	240/cs
RDWL38B	29" x 38"	White	0.79 mil	Roll	240/cs
RDPR38B	29" x 38"	Lavender	0.79 mil	Roll	240/cs
RDPL38B	29" x 38"	Pink	0.79 mil	Roll	240/cs
RDGL38B	29" x 38"	Mint Green	0.79 mil	Roll	240/cs
RDDG38B	29" x 38"	Dark Green	0.79 mil	Roll	240/cs
RDBL38B	29" x 38"	Light Blue	0.79 mil	Roll	240/cs
RDBL38BPC	29" x 38"	Light Blue	0.79 mil	Roll	240/cs
RDBL38C1	29" x 38"	Blue	0.9 mil	Roll	240/cs
<b>33-Gal Capacity</b>					
RDPL43A	29" x 43"	Purple	0.55 mil	Roll	240/cs
RDGL43A	29" x 43"	Mint Green	0.55 mil	Roll	240/cs
RDDG43A	29" x 43"	Dark Green	0.55 mil	Roll	240/cs
Rddb43A	29" x 43"	Dark Blue	0.55 mil	Roll	240/cs
RDBL43A	29" x 43"	Light Blue	0.55 mil	Roll	240/cs
RDYL43B	29" x 43"	Yellow	0.79 mil	Roll	240/cs
RDWL43B	29" x 43"	White	0.79 mil	Roll	240/cs
Rddb43B	29" x 43"	Dark Blue	0.79 mil	Roll	240/cs
RDBL43B	29" x 43"	Light Blue	0.79 mil	Roll	240/cs
RDCL43B	29" x 43"	Clear	0.79 mil	Roll	240/cs
RRDBL45C	29" x 43"	Light Blue	0.9 mil	Roll	240/cs
RHB2945E	29" x 43"	Blue	12 mic	Roll	250/cs
<b>40-45 Gal Capacity</b>					
RDYL45C	40" x 45"	Yellow	0.9 mil	Roll	100/cs



RDBL43A

## Have you heard of our value add program?

This program is a way for customers to get hampers or trash cans free of charge based off their liner usage and price.

- Standard Agreements are usually about 3 years long
- Customers agree to buy a certain amount of liners per month at a set price. **Based off of that usage and price we can give them a certain number of hampers or cans free of charge**

Reach out to your Medline Representative for more information.

# Miscellaneous Specialty Liners

## Blood Ice Bag

- Leakproof double bottom seal
- Additives to help stay flexible in freezing temperatures

Item No.	Size	Color	Thickness	Style	Pkg.
EVS BAGICE1330	13.5" x 30"	Clear	4 mil	Flat	250/cs



EVS BAGICE1330

## Water Soluble Liners

- Isolate or contaminated linen
- Clear bags can be washed along with linen contents
- Bag dissolves in hot water flush at 149°F

Item No.	Size	Capacity	Thickness	Style	Pkg.
NON02800	26" x 33"	15-20 gal	1 mil	Roll	100/cs
NON02825	28" x 39"	30 gal	1 mil	Roll	100/cs
NON02850	36" x 39"	35 gal	1 mil	Roll	100/cs



# Laundry Cart Covers

## Standard Cart Covers

- Composed of virgin resin which outperforms blended and recycled counterparts

Item No.	Size	Color	Thickness	Style	Pkg.
C5265E	29" x 23" x 65"	Clear	1.25 mil	Flat	100/cs
IC5264K	29" x 23" x 64"	Clear	1.4 mil	Flat	100/cs
NON0222991	38" x 26" x 48"	Clear	0.9 mil	Roll	50/cs
NON0222991BIO	38" x 26" x 48"	Clear	0.9 mil	Roll	50/cs
IC6448I	38" x 26" x 48"	Clear	0.95 mil	Flat	150/cs
NON022267	40" x 28" x 67"	Clear	0.8 mil	Roll	125/cs
IRC7460K	42" x 32" x 60"	Clear	1.5 mil	Roll	130/cs
NON022291	45" x 27" x 48"	Clear	0.8 mil	Roll	100/cs
IC7969HI	49" x 30" x 69"	Clear	0.75 mil	Roll	150/cs
IC7878LM	50" x 28" x 71"	Clear	0.5 mil	Roll	150/cs
NON0222992	55" x 30" x 70"	Clear	0.8 mil	Roll	100/cs
NON022290	60" x 30" x 75"	Clear	0.8 mil	Roll	160/cs
IC9274LM	61" x 31" x 74"	Clear	0.5 mil	Roll	100/cs



## Blend Right Cart Covers

- Composed of a mixture of several types of resin to offer a more cost-effective solution

Item No.	Size	Color	Thickness	Style	Pkg.
EVSA1210306YT	12" x 10" x 30"	Yellow	0.6 mil	Roll	450/cs
EVSA2013406C	20" x 13" x 40"	Clear	0.6 mil	Roll	450/cs
EVSA23174011C	23" x 17" x 40"	Clear	1.1 mil	Roll	200/cs
EVSA4032726C	40" x 32" x 72"	Clear	0.6 mil	Roll	450/cs
EVSBAG503048	50" x 30" x 48"	Red	0.7 mil	Roll	100/cs
EVSA54285746C	54" x 28.5" x 74"	Clear	0.6 mil	Roll	450/cs
EVSA58311086C	58" x 31" x 108"	Clear	0.6 mil	Roll	100/cs
EVSA5831806C	58" x 31" x 80"	Clear	0.6 mil	Roll	125/cs
EVSCRTLNR170C	62" x 26" x 73"	Clear	0.65 mil	Roll	200/cs
EVSA62251127C	62" x 25" x 112"	Clear	0.7 mil	Roll	150/cs
EVSA6224698B	62.5" x 24" x 69"	Blue	0.8 mil	Roll	100/cs
EVSCRTLNR180C	68" x 31" x 107"	Clear	0.65 mil	Roll	200/cs



# Equipment Covers

## IV Pole/Garment Bags

- Covers and liners for patient room furniture and equipment

Item No.	Size	Color	Thickness	Style	Pkg.
EVSIVBAG1	21" x 15" x 64"	Clear	0.75 mil	Roll	160/cs
EVSGARMENT1	29" x 54"	Clear	14 mic	Roll	500/cs



EVSIVBAG1

## Bed Bag/Mattress Covers

- Covers and liners for patient room furniture and equipment

Item No.	Size	Color	Thickness	Style	Pkg.
EVSB365144B	36.5" x 144"	Blue	0.7 mil	Roll	100/cs
EVSB365144CP	36.5" x 144"	Clear	0.7 mil	Roll	100/cs
NON0222314	40" x 10" x 90"	Clear	1.5 mil	Roll	30/cs



NON14536

## Wheelchair Covers

Item No.	Size	Color	Thickness	Style	Pkg.
NON0222318	28" x 22" x 35"	Clear	1.0 mil	Roll	100/cs
NON0222317	30" x 20" x 45"	Clear	1.0 mil	Roll	75/cs



NON0222318

## Additional Covers

Item No.	Size	Color	Thickness	Style	Pkg.
<b>Stretch Film</b>					
EVSFILM1	16" x 400 mm	Clear	—	Roll	4/cs
<b>Cart Sheeting</b>					
IBL3858K	38" x 58"	Light Blue	1.5 mil	Roll	100/cs
<b>Ice Bucket Liner</b>					
NONCB1115	8" x 3" x 15"	Clear	0.7 mil	Flat	1,000/cs
<b>Bassinet Cover</b>					
C5432B	36" x 18" x 32"	Clear	1.0 mil	Flat	250/cs

# Reusable Hamper Bags

## Poly Cotton Hamper Bags

- Heavy-duty, poly/cotton bags are strong and reliable
- Made with a round bottom for extra capacity
- Dumping loops for ease of use
- Bags only; hamper not included

Item No.	Closure	Size	Color	Pkg.
MDT021340	Drawcord	18", 30"W x 40"H	Natural	24/cs
MDT021345	Drawcord	25", 40"W x 40"H	Natural	24/cs
MDT021350	Flip Top	18",30"W x 40"H	Natural	24/cs
MDT021351	Flip Top, Elastic	18",30"W x 40"H	Natural	24/cs
MDT021355	Flip Top, Elastic	25", 40"W x 40"H	Natural	24/cs
MDT021362	Flip Top	25", 40"W x 40"H	Natural	24/cs



MDT021340

## Blockade Hamper Bags

- For bagging and transporting soiled linen
- Made with 100% polyester for a high level of fluid resistance
- Retains fluid-resistant properties for up to 75 processings, helping to decrease cost of use
- Handles at the corners of bags for easier handling
- Bags only; hamper not included

Item No.	Style	Size	Color	Pkg.
MDT021370	Chair Back	27"W x 35"H	Gray	12/cs
MDT021366	Chair Back	27"W x 35"H	Yellow	12/cs
MDT021375	Flip Top with Elastic Closure	30"W x 40"H	Ceil Blue	12/cs
MDT021373	Flip Top with Elastic Closure	30"W x 40"H	Gray	12/cs
MDT021353	Flip Top with Elastic Closure	30"W x 40"H	Yellow	12/cs
MDT021377	Flip Top with Elastic Closure	40"W x 35"H	Ceil Blue	12/cs
MDT021374	Flip Top with Elastic Closure	40"W x 35"H	Gray	12/cs
MDT021354	Flip Top with Elastic Closure	40"W x 35"H	Yellow	12/cs



MDT021353

## Sofnit Hamper Bags

- Made with fluid-resistant vinyl fabric
- Ultrasonically sealed seams enhance bag strength
- Can withstand up to 150 processings, decreasing cost of use
- Select cord or flip/elastic cord closure

Item No.	Description	Size	Pkg.
MSC201000C	With Drawcord, Fluid-Resistant	25"	12/cs
MSC201005C	With Drawcord, Fluid-Resistant	18"	12/cs
MSC201100C	With Flip Top, Fluid-Resistant	25"	12/cs
MSC201100ELSC	With Flip Top and Elastic, Fluid-Resistant	18"	12/cs
MSC201105C	With Flip Top, Fluid-Resistant	18"	12/cs
MSC201105ELSC	With Flip Top and Elastic, Fluid-Resistant	18"	12/cs



MSC201000C

# Reusable Hamper Bags

## 200 Denier Nylon Hamper Bags

- Great for storage and transport of dry linens
- Available in chair back, drawcord and flip top with elastic closure
- Bags only; hamper stand not included

Item No.	Style	Size	Color	Pkg.
MDT021344FOR	Chair Back	24"W x 36"H	Forest Green	24/cs
MDT021344NVY	Chair Back	24"W x 36"H	Navy Blue	24/cs
MDT021344ROY	Chair Back	24"W x 36"H	Royal Blue	24/cs
MDT021344	Chair Back	24"W x 36"H	White	24/cs
MDT021344YEL	Chair Back	24"W x 36"H	Yellow	24/cs
MDT021348	Drawcord	30"W x 40"H	White	24/cs
MDT021349	Drawcord	40"W x 35"H	White	24/cs
MDT021363	Flip Top with Elastic Closure	30"W x 40"H	White	24/cs
MDT021364	Flip Top with Elastic Closure	40"W x 35"H	White	24/cs

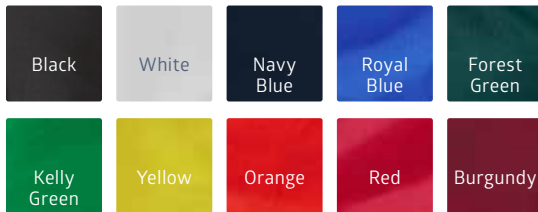

Contact your Medline Representative to order additional colors.

## Washable Mesh Laundry Bags

- Eliminate the hassle of sorting patient laundry
- Contents can be washed and dried in the bag to keep separate from other laundry and linens
- Polyester mesh weave allows water and soap to penetrate, minimizing odors and mold caused when storing damp items

Item No.	Size	Color	Style	Pkg.
MDT2436MD	24" x 36"	White	Drawcord Closure	12/cs
MDT2436HN	24" x 36"	White	Open, Heavy Mesh	12/cs
MDT2436MNID	24" x 36"	White	Open, ID Patch	12/cs
MDT2436MZ	24" x 36"	White	Zipper Closure	12/cs
MDT3040HD	30" x 40"	White	Drawcord Closure, Heavy Mesh	12/cs
MDT3040HN	30" x 40"	White	Open, Heavy Mesh	12/cs
MDT3040HNID	30" x 40"	White	Open, ID Patch	12/cs
MDT3040MD	30" x 40"	White	Open	12/cs
MDT3040MZ	30" x 40"	White	Zipper Closure	12/cs



Contact your Medline Representative to order additional colors.



MDT021344YEL  
Chair back

MDT021348ORG  
Drawcord

MDT021364ROY  
Flip Top with  
elastic closure



Drawcord closure

Zipper closure

# Reusable Hamper Bags

## Sofnit Biohazard Hamper Bags

- Fluid-resistant vinyl fabric; up to 150 processings
- Red biohazard logo promotes caution and safety
- Ultrasonically-sealed seams offer strength, durability and the highest level of fluid protection
- Select cord or flip/elastic cord closure

Item No.	Description	Cord Length	Pkg.
MSC201005BIO	Biohazard, Cord	18"	12/cs
MSC201000BIO	Biohazard, Cord	25"	12/cs
MSC201105EBIO	Biohazard, Flip/Elastic, Cord	25"	12/cs



MSC201005BIO

## Reject Linen Hamper Bag

- Reusable bag can withstand up to 50 industrial launderings for a lower carbon footprint
- Black "REJECT LINEN" print on Orange bag for easy identification
- Drawstring cord closure with barrel lock
- Sturdy 100% polyester
- Great for storing torn, stained, and defective linens, too

Item No.	Description	Bag Opening	Pkg.
MDTHB4P18ORG	30"W x 40"H, Drawcord	18" Diameter	12/cs



MDTHB4P18ORG

# Hampers

## Soiled Linen Carts

- Hands-free lid opens easily with a foot pedal and shuts automatically to help with odors
- Bags lock easily into place with no-slip friction bar; rolled bags store easily in Wallaby™ pouch or basket on the back of the hamper
- Open-frame design helps reduce heavy upward lifting
- Casters designed to help prevent marking on floors

Item No.	Liner Size	Description	Pkg.
<b>Assembled</b>			
CX502	29" x 38"	Cart with Wallaby, "Soiled Linen" Lid, Small	1 ea
CX402	29" x 33"	Cart with Wallaby, "Soiled Linen" Lid, Medium, Tall Base	1 ea
CX302	29" x 38"	Cart with Wallaby, "Soiled Linen" Lid, Medium	1 ea
CX102	29" x 43"	Cart with Wallaby, "Soiled Linen" Lid, Large	1 ea
CX7	29" x 38"	ContinuCart with "Soiled Linen" Lid, Medium	1 ea
CX9	29" x 43"	ContinuCart with "Soiled Linen" Lid, Large	1 ea
<b>Unassembled</b>			
MDS80530KD	29" x 38"	Cart with Wallaby, Large, Triangle, Quiet Close, Metal Lid	1 ea
MDS80529	29" x 43"	Cart with Wallaby, Plain Lid, Large, Metal Painted Lid	1 ea
MDS802525	29" x 43"	Cart, Large, No Lid, X-Frame	1 ea



CX102



CX302



CX402



CX502



CX9

# Trash Cans

## Plastic Step-On Trash Cans

- Plastic trash cans with foot-operated pedal for hands-free disposal

Item	Capacity	Size	Color	Pkg.
DET8BE	8 Gal	18.9"L x 12.8"W x 19.7"H	Beige	1 ea
DET8RD	8 Gal	18.9"L x 12.8"W x 19.7"H	Red	1 ea
DET13BE	13 Gal	18.9"L x 12.8"W x 27.3"H	Beige	1 ea
DET13RD	13 Gal	18.9"L x 12.8"W x 27.3"H	Red	1 ea
DET18BE	18 Gal	22.8"L x 15.5" W x 26.3"H	Beige	1 ea
DET18RD	18 Gal	22.8"L x 15.5" W x 26.3"H	Red	1 ea
DET24BE	24 Gal	22.8"L x 15.5" W x 32.2"H	Beige	1 ea
DET24RD	24 Gal	22.8"L x 15.5" W x 32.2"H	Red	1 ea



DET8RD

DET24BE

## Square/Rectangle Metal Step-On Cans

- Metal trash cans with foot-operated pedal for hands-free disposal
- Premium quality stainless steel or baked epoxy finish compliment any décor

Item No.	Size	Color	Pkg.	Item No.	Size	Color	Pkg.
DETC16	16 qt	Steel	1 ea	MPHP32R	32 qt	Red	1 ea
DETP16RD	16 qt	Red	1 ea	DETP32	32 qt	White	1 ea
DETP16	16 qt	White	1 ea	DETC48	48 qt.	Steel	1 ea
DETC24SS	24 qt	Steel	1 ea	MPHP48R	48 qt	Red	1 ea
MPHP24R	24 qt	Red	1 ea	MPHP48	48 qt	White	1 ea
DETP24W	24 qt	White	1 ea				



DETC328SS

## Fire-Rated Desk Side Cans

- For use in patient rooms, nurses stations and other small areas
- UL® Classified cans made from thermoset material with fiberglass reinforcement

Item No.	Size	Color	Pkg.	Item No.	Size	Color	Pkg.
MABMB8BEI	8 qt	Beige	6/cs	MABMB27BEI	27 qt	Beige	6/cs
MABMB8BLK	8 qt	Black	6/cs	MABMB27BLK	27 qt	Black	6/cs
MABMB8BLU	8 qt	Blue	6/cs	MABMB27BLU	27 qt	Blue	6/cs
MABMB8B	8 qt	Brown	6/cs	MABMB27BRN	27 qt	Brown	6/cs
MABMB8GRA	8 qt	Gray	6/cs	MABMB27GRAY	27 qt	Gray	6/cs
MABMB8GRN	8 qt	Green	6/cs	MABMB27	27 qt	Sand	6/cs
MABMB8	8 qt	Sand	6/cs	MABMB40BEI	40 qt.	Beige	4/cs
MABMB14BEI	14 qt	Beige	6/cs	MABMB40BLA	40 qt	Black	4/cs
MABMB14BLK	14 qt	Black	6/cs	MABMB40BLU	40 qt	Blue	4/cs
MABMB14BLU	14 qt	Blue	6/cs	MABMB40BRN	40 qt.	Brown	4/cs
MABMB14BRN	14 qt	Brown	6/cs	MABMB40GRA	40 qt	Gray	4/cs
MABMB14GRAY	14 qt	Gray	6/cs	MABMB40GRN	40 qt	Green	4/cs
MABMB14	14 qt	Sand	6/cs	MABMB40	40 qt	Sand	4/cs



EVSTCFR40BLK

EVSTCFR40SND

# Trash Cans

## Soft-Side Desk Cans

- Molded of high-quality polyethylene for strength and durability
- All plastic construction ensures wastebasket will not dent, chip, or rust

Item No.	Size	Color	Pkg.	Item No.	Size	Color	Pkg.
SRW12BLK	12 qt	Black	12/cs	EVSTC77025	28 qt	Black	12/cs
EVSTC770115	14 qt	Beige	12/cs	EVSTC77023	28 qt	Gray	12/cs
EVSTC77014	14 qt	Brown	12/cs	SRW40BLK	40 qt	Black	12/cs
EVSTC77013	14 qt	Gray	12/cs	SRW40BLU	40 qt	Blue Recycle	12/cs
EVSTC770215	28 qt	Beige	12/cs	EVSTC770315	41 qt	Beige	12/cs
SRW28BLU	28 qt	Blue Recycle	12/cs	EVSTC77033	41 qt	Gray	12/cs



EVSTC770211R

EVSTC770315

## Large Round Trash Containers

- Deeper, wider bottom hand grip pockets slot for easier container dumping
- Offset ridge design allows container to nest without jamming
- Matching lids available upon request

Item No.	Size	Color	Pkg.
EVSTRDI10WH	10 gal	White	6/cs
EVSTRDI20WH	20 gal	White	6/cs
EVSTRDI20GRY	20 gal	Gray	6/cs
EVSTRDI32WH	32 gal	White	5/cs
SRWTRD32GRA	32 gal	Gray	1 ea
EVSTRDI32BLU	32 gal	Blue	6/cs
EVSTRDI32RED	32 gal	Red	6/cs
EVSTRDI32YEL	32 gal	Yellow	6/cs
EVSTRD44WH	44 gal	White	4/cs
SRWTRD44GRA	44 gal	Gray	1 ea
SRWTRD44BLU	44 gal	Blue	1 ea
EVSTC77446	44 gal	Red	4/cs
SRWTRD44YEL	44 gal	Yellow	1 ea
SRWTRD55BLU	55 gal	Blue	1 ea
SRWTRD55GRA	55 gal	Gray	1 ea



EVSTC20GRA

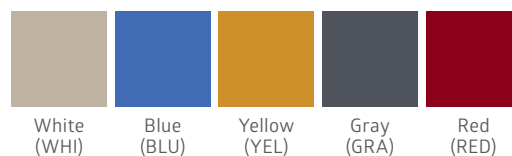

## Trash Dollies

- Round dolly holds up to 55-gallon cans

Item No.	Description	Color	Pkg.
EVSTC7704	Dolly	Black	2/cs
EVSTC7705	Dolly with Quiet Casters	Black	2/cs



EVSTC7705

# Trash Cans

## Thin Bin® Containers

- Heavy-duty polymer for strength and rigidity
- Engineered sidewall venting for easy retrieval of loaded trash bags
- Recycling and swing-top lids available upon request

Item No.	Size	Color	Pkg.
EVSTCTHIN23BK	23 gal	Black	1 ea
EVSTCTHIN23BL	23 gal	Blue	1 ea
EVSTCTHIN23GY	23 gal	Gray	1 ea
EVSTC702315	23 gal	Beige	4/cs



EVSTCTHIN23BK



EVSTCTHIN23BL

## Metal Trash Cans

- Highly-attractive and easy to access bins provide the perfect experience
- Fingerprint-resistant Stainless Steel and Black options match any décor

Item No.	Size	Color	Pkg.
MDINTSRS18SS	18 gal	Silver	1 ea
MDVENUCOL20BL	20 gal	Silver	1 ea
MDVENUCOL20SS	20 gal	Silver	1 ea
MDBLKSR24CB	24 gal	Black	1 ea
MDBLKSR24PAP	24 gal	Black	1 ea
MDBLKSR24PLS	24 gal	Black	1 ea
MDBLKSR24RCY	24 gal	Black	1 ea
MDBLKSR24TRS	24 gal	Black	1 ea



MDVENUCOL20SS

## Liquid Waste Receptacles

- 16-gauge stainless steel fabricated body all welded construction with seamless top
- 4 heavy-duty casters included for mobility

Item No.	Capacity	Color	Pkg.
MDLIQUIDWASTE	10 gal	Steel	1 ea
MDLWRECYL	24 gal	Steel	1 ea
MDLWTRASH	24 gal	Steel	1 ea



MDLWRECYL

# Trash Cans

## Waste Carts

- Added caster wheels eliminate the need to tilt the cart to roll, helping stabilize heavy loads
- 360-degree rotating steel stop bar makes automated trash pickup a breeze

Item No.	Capacity	Wheels	Color	Pkg.
TOTWC3260594	32 gal	2	Gray	1 ea
TOTWC3257311	32 gal	2	Blue	1 ea
TOTWC3255410	32 gal	2	Green	1 ea
TOTWC4800GST	48 gal	2	Gray	1 ea
TOTWC4810454	48 gal	2	Blue	1 ea
TOTWC4851406	48 gal	2	Green	1 ea
TOTWC4856599	48 gal	2	Black	1 ea
TOTWC6410827	64 gal	2	Gray	1 ea
TOTWC6400BLU	64 gal	2	Blue	1 ea
TOTWC6457359	64 gal	2	Green	1 ea
TOTWC6410548	64 gal	2	Black	1 ea
TOTWC9610599	96 gal	2	Gray	1 ea
TOTWC9657430	96 gal	2	Blue	1 ea
TOTWC9654342	96 gal	2	Green	1 ea
TOTWC9600BKS	96 gal	2	Black	1 ea
TOTACC6454647	64 gal	4	Gray	1 ea
TOTACC9654689	96 gal	4	Gray	1 ea



TOTWC6410548

## Secure Document Management Cans

- Locking lids keep confidential documents securely contained
- Added casters eliminate the need to tilt the cart to roll helping stabilize heavy loads

Item No.	Capacity	Color	Pkg.
TOTCDC32GRA	32 gal	Gray	1 ea
TOTCDC64GRA	64 gal	Gray	1 ea
TOTCDC96GRA	96 gal	Gray	1 ea



TOTCDC96GRA

# Trash Cans

## Medical Waste Containers

- Smooth interior is easy to clean between uses
- Locking lid with gasket seal keeps contents securely contained

Item No.	Capacity	Wheels	Color	Pkg.
TOTMWC3200RED	32 gal	2	Red	1 ea
TOTMWC6401RED	64 gal	2	Red	1 ea
TOTMWC9600RED	96 gal	2	Red	1 ea
TOTMWC3200RED	32 gal	4	Red	1 ea
TOTMWC6401RED	64 gal	4	Red	1 ea
TOTMWC9600RED	96 gal	4	Red	1 ea



TOTMWC3200RED

## PPE Carts

- ANSI-compliant trash cans help quickly and easily collect, consolidate and transport waste
- Lid secures in place for safe transport

Item No.	Capacity	Color	Pkg.
TOTPPECC32	32 gal	Black	1 ea
TOTPPECC64	64 gal	Black	1 ea
TOTPPECC96	96 gal	Black	1 ea



TOTPPECC64

## Decorative Outdoor Trash Cans

- Decorative outdoor trash cans can disguise unsightly trash from on-lookers

Item No.	Capacity	Color	Pkg.
SMKROASIS	4.5 gal	Black	1 ea
EVBULLET	21 gal	Beige	1 ea
SRWMTC SQ300	30 gal	Black	1 ea
SRWMTC SQ305	30 gal	Black	1 ea
SRWMTCRND3502	35 gal	Black	1 ea
SRWMTCRND3501	35 gal	Black	1 ea
MDR9472NC	38 gal	Black/Pebbled	1 ea
SRWMTCPERFRM5	55 gal	Silver	1 ea
MDSDBRELPSE	90 gal	Bronze	1 ea



MDSDBRELPSE

# Cleaning Tools and Cart Necessities



# Brooms and Dust Pans

## Lobby Dust Pan

- Blade on the pan head provides good floor contact
- Pan head swivels up when carrying
- Made of high-impact plastic

Item No.	Description	Pkg.
EVS2600	Lobby Dust Pan	1 ea



EVS2600

## Angled Broom

- Angled and flagged synthetic bristles
- Sweeps fine particles as well as fine debris
- Smooth plastic fibers are washable, durable and water resistant

Item No.	Description	Pkg.
EVSTOOL300F	Angled Broom with Wood Handle	1 ea



EVSTOOL300F

## Lobby Dust Broom

- Stiff plastic bristles resistant breakage and shedding
- Angled, frayed, bristle construction
- Water resistant
- Hang-up hole on top of handle

Item No.	Description	Pkg.
EVS2601	Lobby Dust Broom	12/cs
EVS2601H	Lobby Dust Broom	1 ea



EVS2601H

## Hand Dust Pan

- Heavy duty
- Molded ridges for broom and counter brush cleaning
- Fine line edge for maximum pickup

Item No.	Description	Pkg.
EVSTOOL333	Hand Dust Pan, 12", Black	12/cs



EVSTOOL333

# Sweepers and Dusters

## Squeegee Sweeper

- Disposable bag collection system includes a squeegee, dust pan and disposable bag
- Helps prevent transferring dust to the air or other surfaces
- Does not require special bag; can be used with existing liners
- An easy way to clean up messes

Item No.	Description	Pkg.
MPHMCPA20400E	Squeegee Sweeper, Blue	1 ea
MPHMCPA20300C	Squeegee Sweeper, Blue	12/cs



MPHMCPA20300C

## Traditional Duster

- Lambswool duster quickly and easily lift fine dust particles without harming surfaces
- When it becomes heavily soiled, this duster may be washed out and conveniently hung to dry by a hole in the handle
- Handle extends from 38"-50"

Item No.	Description	Pkg.
EVSTOOL470	Lambswool Duster with Extendable Handle	1 ea



EVSTOOL470

## Polywool Duster

- Made of gentle materials and is fully washable
- Metal handle is coated with plastic

Item No.	Description	Pkg.
EVSTOOL471	Polywool Duster, 23"L	12/cs



EVSTOOL471

## Cling and Clean Dust Sheets

- Disposable two-sided sheets help double your cleaning power
- Proprietary adhering agents trap more dust, dirt, hair and lint deep inside

Item No.	Description	Pkg.
EVSTOOL425	8" x 6", 250 Sheets/Roll	1 bx
EVSTOOL428	5" x 6", 60 Sheets/Roll	8 bx/cs



EVSTOOL425

# Mop Buckets and Signs

## Mop Buckets with Wringer

- High-density polypropylene
- 3" non-marking swivel casters and protective bumpers
- Yellow with "Caution" printed on sides
- Wringer features a corrosion-resistant handle and accommodates 12-oz to 32-oz mops
- 35-qt. capacity



Item No.	Description	Pkg.
EVSTOOL463	Bucket with Down Wringer	1 ea
EVSTOOL464	Bucket with Side Wringer	1 ea

## "CAUTION Wet Floor" Sign

- Highly visible helps secure areas that need to be marked off
- Impact resistant
- Folds flat for space-saving storage
- Ridges on feet to minimize contact with floors



Item No.	Description	Color	Pkg.
EVS9152H	10.75"L x 1"W x 24.63"H	Yellow	1 ea
EVS9152	10.75"L x 1"W x 24.63"H	Yellow	6/cs

## Pop-out Safety Cones

- Yellow and Black safety cone helps secure areas
- Features a symbol for wet floor and trilingual message on each of the three sides to help ensure readability
- Plastic storage tube allows multiple mounting options; hardware included
- Cone measures 18.75"W x 18.75"D



Item No.	Description	Pkg.
EVSTOOL901	Pop-Out Cone, 31"H	1 ea
EVSTOOL902	Pop-Out Cone, 20"H	1 ea

# Handles

## Fiberglass Handle Jaw

- Extra-durable jaws head
- Secure grip and easy changes with threaded compression collar

Item No.	Description	Pkg.
EVSTOOL111F	Mop Handle Jaw, 1" x 60"	1 ea

## Traditional Quick Change Wet Mop Handle

- Polypropylene-molded head for corrosion resistance
- Wide head for fitting any-sized mop; ideal for narrow band heads

Item No.	Description	Pkg.
EVSTOOL121P	Mop Handle Quick Change, 1" x 60"	1 ea



EVSTOOL111F



EVSTOOL121P

## Threaded Broom Handle

- Fiberglass handle with black nylon threaded tip is ideal for push brooms, street brooms and squeegees

Item No.	Description	Pkg.
EVSTOOL101B	Threaded Fiberglass 60" Handle	1 ea



EVSTOOL101B

# Scrapers

## Putty Knife

- Comfortable polypropylene handle
- Stainless steel blade

Item No.	Description	Color	Pkg.
EVSTOOL490	1.25"W x 8"L	Black	12/pk



EVSTOOL490

## Floor Scrapers

- Ideal for removing gum, tape and wax buildup
- Reversible, tempered, 4" steel blade has a blunt edge and a razor edge
- Includes blade cover for safe transport and storage

Item No.	Description	Pkg.
EVSTOOL141	Scraper, Long Handle, 48"	1 ea
EVSTOOL142	Handheld Scraper, 12"	1 ea
EVSTOOL143	Replacement Blades	60/cs



EVSTOOL142



EVSTOOL141

# Bottles

## Plastic Bottle and Accessories

- For mixing and dispensing concentrated cleaning products
- Graduated for convenient measuring
- Sprayer and flip-top cap sold separately

Item No.	Description	Pkg.
EVS4932H	Plastic Bottle, 32 oz	1 ea
EVS4900H	Trigger Sprayer	1 ea
EVSCHEM010	Flip-Top Cap	1 ea



EVS4932H



EVS4900H

## Bottles with Trigger Sprayer

- For mixing and dispensing concentrated cleaning products
- Graduated for convenient measuring

Item No.	Description	Pkg.
EVS5024WG	Bottle and Trigger, 24 oz	6/cs
EVS5016	Bottle and Trigger, 16 oz	6/cs



EVS5024WG

## Pump

- Fits standard gallon
- Used in food and cleaning applications

Item No.	Description	Pkg.
EVSTOOL480	Gallon Bottle Pump	24/cs



EVSTOOL480

# Brushes and Sponges

## Tile and Grout Brush

- Plastic-handled grout brush with nylon bristles
- Handle features hole on top for hanging

Item No.	Description	Pkg.
EVSTOOL431	Tile and Grout Nylon Brush	1 ea



EVSTOOL431

## Hand Pads

- Made of polyester fibers in an open-textured, nonwoven pattern
- Abrasive particles are dispersed throughout and bonded to the nonwoven construction with a durable adhesive
- Designed for cleaning of floors, baseboards and corners

Item No.	Description	Pkg.
EVSHPAD32BRCS	Heavy-Duty Utility Pad, Brown	20/cs
EVSHPAD31BCS	Medium-Duty Utility Pad, Blue	20/cs
EVSHPAD11GCS	Medium-Duty Scrubbing Sponge, Green	20/cs
EVSHPAD10WCS	Light-Duty Scrubbing Sponge, White	20/cs
EVSHPAD22GCS	Heavy-Duty Scouring Pad, Green	60/cs
EVSHPAD21GCS	Medium-Duty Scouring Pad, Green	60/cs

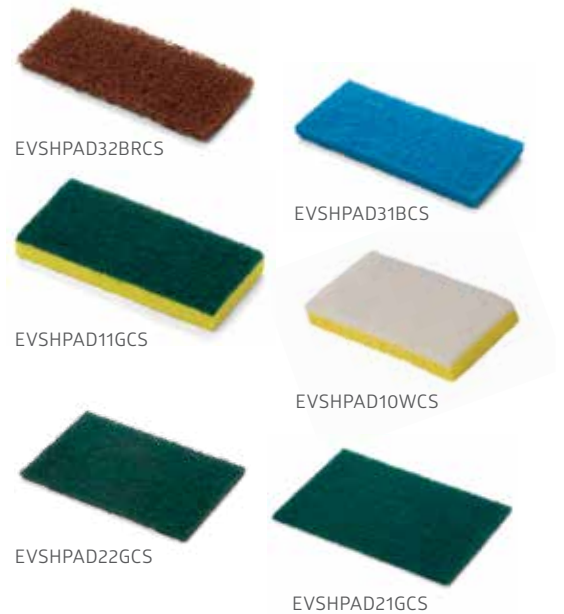

EVSHPAD32BRCS

EVSHPAD31BCS

EVSHPAD11GCS

EVSHPAD10WCS

EVSHPAD22GCS

EVSHPAD21GCS

## Amazing Sponge

- Be prepared to be “wowed” by this extra powerful sponge
- Fits comfortably in hand
- Melamine cleaning surface on both sides
- Green grip in middle prolongs use and improves performance
- Larger surface area for extended durability

Item No.	Description	Pkg.
EVS7150	Amazing Sponge	30/cs



EVS7150

# Toilet Bowl Cleaning

## Cleaning Tools

- Mop features a strong 12" plastic handle and 4" strands of acid-resistant polypropylene
- Cylindrical bowl brush has 11" plastic handle with cylindrical staple fibers to prevent scratching surfaces

Item No.	Description	Pkg.
EVS204	Toilet Bowl Mop	100/cs
EVS204H	Toilet Bowl Mop	1 ea
EVSTOOL412	Toilet Bowl Brush	1 ea
EVSTOOLPUM	Pumice Scouring Stick	12/cs



EVSTOOL412

EVS204H

## Toilet Plunger

- Large cup for maximum pressure
- 21", heavy-duty wooden handle

Item No.	Description	Pkg.
EVSTOOL450	Toilet Plunger	1 ea



EVSTOOL450

## Caddies

- White plastic toilet bowl caddy conveniently holds toilet bowl mop and cleaner
- Handy maid's caddy fits most carts and features a handle, 3 molded compartments for supplies and 2 small item trays

Item No.	Description	Pkg.
EVS18801	Toilet Bowl Caddy	12/cs
EVSTOOL1850	Premium Caddy	4/cs
EVSTOOL1802	Caddy	6/cs



EVS18801



EVSTOOL1802



EVSTOOL1850

## Scented Urinal Screens

- Screen EVSTOOL501 has tapered drain holes to help prevent splash-back; measures 8" L x 8" W and fits most urinals
- Screen EVSTOOL502 has strong sudsing action to help assure sanitation; built-in hook for easy removal; measures 6.75" L x 6.75" W
- Both are cherry scented

Item No.	Description	Pkg.
EVSTOOL501	Deluxe Urinal Screen, Red/Cherry	50/cs
EVSTOOL502	Urinal Screen Block, Cherry	12/cs



EVSTOOL501



EVSTOOL502

# Floor Care



Schneider Electric  
Uddannelsescenter



# Floor Mats

## Three Mat Entry System

Protect your floors and the people who walk on them with a three-mat entry system to help prevent tracking. Having the right entrance matting will keep your facility safer, cleaner and more comfortable.

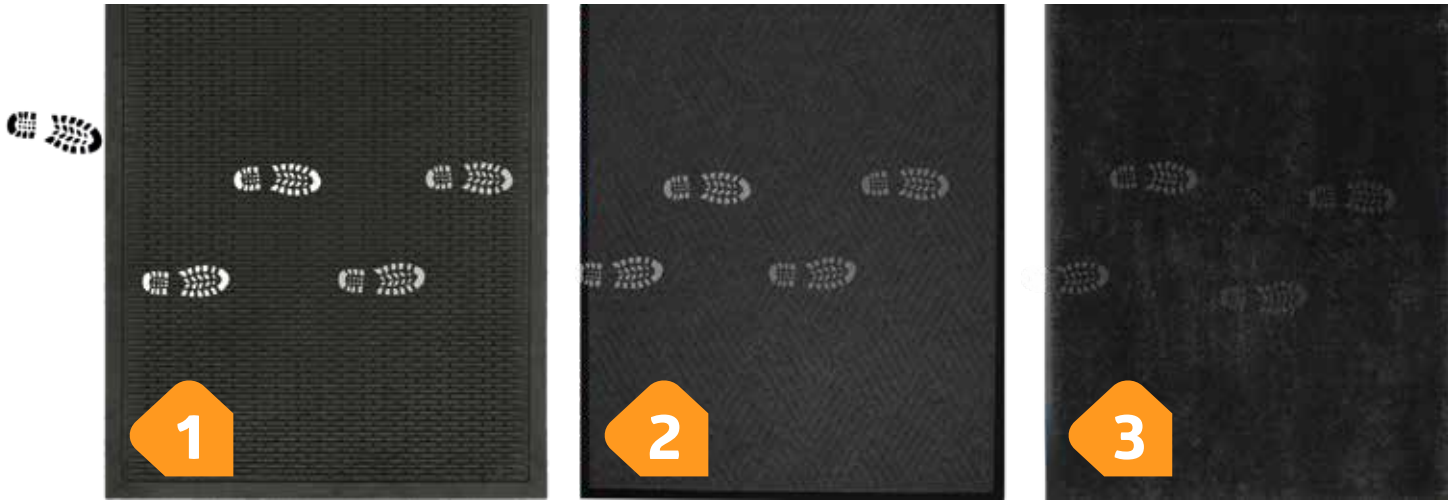

**1**  
Scraper  
Mat

**2**  
WaterHog  
(Scraper/Wiper) Mat

**3**  
Carpeted  
(Wiper) Mat

### 1

#### SuperScrape™ Mats

- **Clean**—Surface cleats help remove and trap dirt and sand below shoe level to prevent tracking
- **Safe**—Slip-resistant even in wet environments; certified high-traction by the National Floor Safety Institute (NFSI)
- **Durable**—Grease/oil proof; chemical resistant
- **Easy to clean**—Lightweight flexible design ensures easy handling and cleaning (shake off soil and hose off)

Item No.	Size	Pkg.
MAC5553X5	3' x 5'	1 ea
MAC5554X6	4' x 6'	1 ea
MAC5556X8	6' x 8'	1 ea

Additional sizes and colors available.



MAC5553X5

# Floor Mats

2

## WaterHog® Diamond Mats

- **Clean and dry**—Bi-level surface effectively scrapes dirt and moisture from shoes, trapping it beneath shoe level to prevent tracking; water dam border holds moisture keeping it off your floors (WaterHog mats can hold up to 1.5 gallons of water per square yard)
- **Durable**—Reinforced rubber nubs prevent pile from crushing and extend the performance life of the mat
- **Fade and stain resistant**—Solution-dyed, eco-friendly PET fabric is resistant to staining, dries quickly and will not fade or rot
- **Safe**—Beveled edges provide a safe transition from floor to mat; certified high-traction by the NFSI

Item No.	Size	Color	Pkg.
MAC2083X5CH	3' x 5'	Charcoal	1 ea
MAC2083X10CH	3' x 10'	Charcoal	1 ea
MAC2084X6CH	4' x 6'	Charcoal	1 ea



MAC2083X10CH

3

## Color Star® Carpeted Mats

- **Eco-Friendly**—ColorStar mats are made with PET (polyethylene terephthalate), a type of polyester yarn that features 100% recycled content reclaimed from plastic
- **Fade Resistant**—PET yarn has excellent color-fastness and is resistant to fading from repeated washing or cleaning
- **Stain Resistant**—PET yarn is naturally stain resistant, making it easy to remove stains from the mat
- **Safe**—Certified high-traction by the NFSI

Item No.	Size	Pkg.	Item No.	Size	Pkg.
MAC1002X4	2' x 4'	1 ea	MAC1004X40	4' x 40'	1 ea
MAC1002X5	2' x 5'	1 ea	MAC1005X8	5' x 8'	1 ea
MAC1003X6	3' x 6'	1 ea	MAC1005X10	5' x 10'	1 ea
MAC1003X10	3' x 10'	1 ea	MAC1005X18	5' x 18'	1 ea
MAC1003X23	3' x 23'	1 ea	MAC1006X7	6' x 7'	1 ea
MAC1004X6	4' x 6'	1 ea	MAC1006X8	6' x 8'	1 ea
MAC1004X8	4' x 8'	1 ea	MAC1006X12	6' x 12'	1 ea
MAC1004X10	4' x 10'	1 ea			
MAC1004X29	4' x 29"	1 ea			

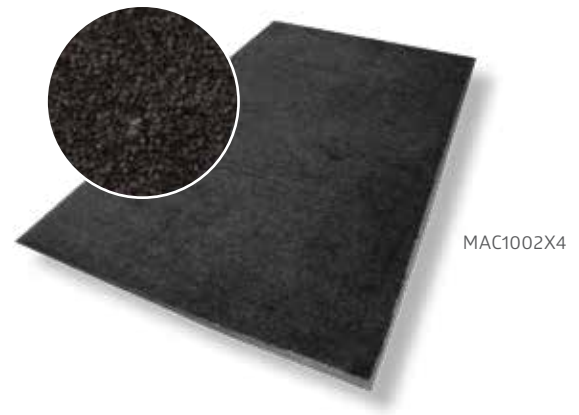

MAC1002X4

Autumn Brown (26)	Cranberry (41)	Red/Black (1)
Black Opal (45)	Dark Granite (5)	Slate (43)
Blueberry Frost (33)	Emerald Green (19)	Solid Black (4)
Browntone (2)	Glen Green (29)	Solid Red (21)
Burgundy Berry (27)	Grey (11)	Stardust Grey (31)
Cabot Grey (3)	Midnight Blue (25)	Steel Blue (28)
Charcoal (13)	Navy (16)	Suede (32)
Chocolate (9)	Platinum (14)	

# Floor Mats

## Dura Comfort Anti-Fatigue Mats

- **Comfortable**—High-density nitrile-blended cushion helps provide excellent anti-fatigue qualities
- **Safe**—Certified high-traction by the NFSI
- **Durable**—Nitrile-blended cushion provides years of useful service life; cushion is molded, not glued, to the nitrile rubber surface so it will not separate; edges will not crack or curl
- **Versatile**—Welding safe; ESD rating of electrically conductive; chemical resistant; surface is grease/oil proof and cushion is grease/oil resistant; suitable for both wet and dry environments

Item No.	Size	Color	Pkg.
MAC4652X3	2' x 3'	Black	1 ea
MAC4653X5	3' x 5'	Black	1 ea



MAC4652X3

## Wet Step Mats

- **Slip-resistant and safe**—Great for showers and scrub sink areas. Drainage holes allow water to freely drain away; certified high-traction by the National Floor Safety Institute (NFSI)
- **Comfortable**—0.25" thick high-density nitrile rubber foam provides excellent anti-fatigue properties making it very comfortable for bare feet
- **Clean**—Anti-microbially treated\* to help prevent odors and degradation; can be autoclave sterilized
- **Durable**—Nitrile rubber foam is UV resistant and provides years of service life

Item No.	Size	Color	Pkg.
MAC7892X3	2' x 3'	Gray or Blue	1 ea
MAC7893X5	3' x 5'	Gray or Blue	1 ea
MAC7893X10	3' x 10'	Gray or Blue	1 ea

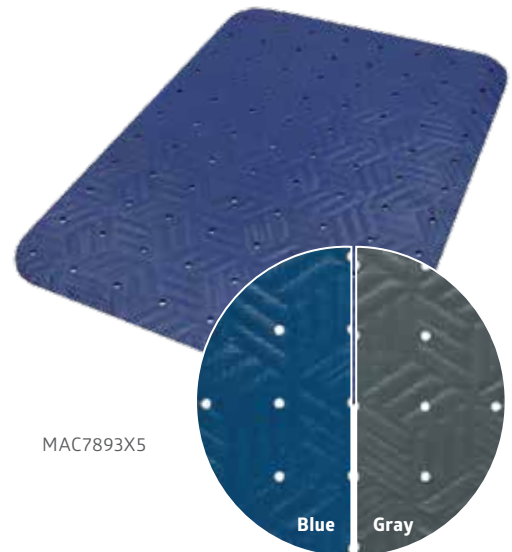

MAC7893X5

\*This product is treated with an antimicrobial agent built in to protect the product. This product does not protect users or others against bacteria, viruses, germs or other disease organisms. This product has been treated to resist bacterial odors.

## Cushion Station Anti-Fatigue Mats

- Constructed of a combination of durable dense closed cell nitrile rubber and foam
- Has drainage holes

Item No.	Size	Color	Pkg.
MAC3712X32	2' x 3.2'	Black	1 ea
MAC37132X53	3.2' x 5.3'	Black	1 ea
MAC37132X83	3.2' x 8.3'	Black	1 ea

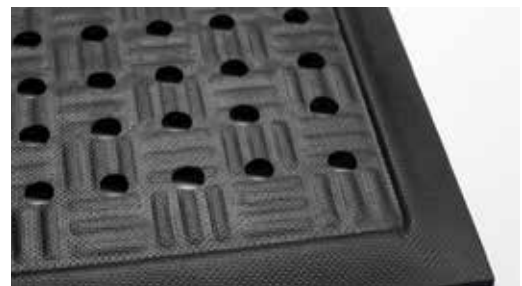

# Floor Mats

## Complete Comfort Mats

- Ergonomically superior antifatigue mats designed for dry or damp environments
- **Comfortable**—5/8" thick nitrile/PVC-blended foam provides superior anti-fatigue properties
- **Clean**—Antimicrobial\* treatment provides lifetime protection from odors and degradation
- **Safe**—Beveled edges provide a safe transition from floor to mat; certified high-traction by the National Floor Safety Institute (NFSI)
- **Easy to Clean**—Lightweight and flexible for easy handling and cleaning
- **Durable**—Grease and oil resistant; chemical resistant

Item No.	Size	Pkg.
MAC4942X3	2' x 3'	1 ea
MAC4943X4	3' x 4'	1 ea
MAC4943X10	3' x 10'	1 ea

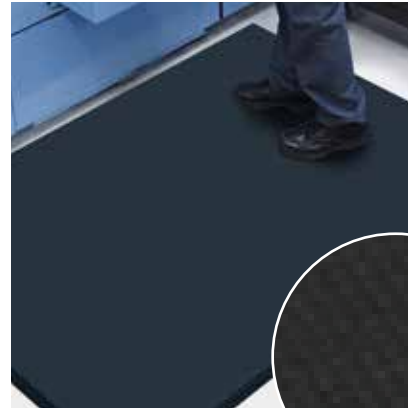

MAC4942X3

## Cushion Station™ Mats

- **Comfortable**—7/16" nitrile foam provides excellent anti-fatigue properties
- **Clean**—Antimicrobial\* protection is built into the mat to help prevent stains and odors caused by bacteria, mold and mildew, for the lifetime of the product
- **Safe**—Beveled edges provide a safe transition from the floor to the mat; certified high-traction by the NFSI
- **Versatile**—Grease/oil proof; chemical resistant
- **Easy to clean**—Flexible construction makes this mat easy to clean; can be autoclave sterilized

Item No.	Description	Pkg.
MAC3702X32	2' x 3.2', Black	1 ea
MAC37032X53	3.2' x 5.3', Black	1 ea
MAC3704X123	4' x 12', Black	1 ea



MAC37032X53

## Hog Heaven® Mats

- **Comfortable**—High-density nitrile blended cushion helps eliminate pressure to the lower back and legs, providing superior comfort
- **Safe**—Certified high-traction by the NFSI
- **Durable**—Nitrile-blended cushion provides years of useful service life; cushion is molded, not glued, to the nitrile rubber surface so it will not separate; edges will not crack or curl
- **Versatile**—ESD rating of electrically conductive; chemical resistant; surface is grease/oil proof and cushion is grease/oil resistant

Item No.	Description	Pkg.
MAC4213X5	3' x 5' x 0.625"; Black	1 ea
MAC4233X5	3' x 5' x 0.625"; Black with Yellow Striped Border	1 ea
MAC4223X5	3' x 5' x 0.875"; Black	1 ea
MAC4243X5	3' x 5' x 0.875"; Black with Yellow Striped Border	1 ea



MAC4223X5

\*This product is treated with an antimicrobial agent built in to protect the product. This product does not protect users or others against bacteria, viruses, germs or other disease organisms. This product has been treated to resist bacterial odors.

# Floor Mats

## CleanShield® Universal Mats

- **Minimizes odors**—Silver ion fibers provide antimicrobial\* protection from odors and degradation
- **Protects floors and dries quickly**—Seep-Guard barrier eliminates urine seepage, protecting your floors from damage caused by uric acid; surface dissipates water quickly for fast drying time
- **Stays in place**—Tacki-Back adhesive keeps the mat flat and in place
- **Hassle Free**—Mats can be left in place during daily floor cleaning; floor scrubbers, mops and brooms will pass right over them without causing damage
- **Safe**—Certified high-traction by the NFSI

Item No.	Description	Size	Color	Pkg.
MAC4075	Universal Commode Mat	21.25" x 20.25"	Charcoal	6/cs
MAC4065	Urinal Mat	21.25" x 20.25"	Charcoal	6/cs

\*This product is treated with an antimicrobial agent built in to protect the product. This product does not protect users or others against bacteria, viruses, germs or other disease organisms. This product has been treated to resist bacterial odors.



MAC4075

## Sticky Mats

- Multi-layered, adhesive-coated mat made of low-density polyethylene
- Removes and traps unwanted dirt, dust and debris from foot traffic and wheels
- 30 mats per pad

Item No.	Size	Color	Pkg.
EVSPM183634B	18" x 36"	Blue	4/cs
EVSPM184534W	18" x 45"	White	4/cs
EVSPM184534B	18" x 45"	Blue	4/cs
EVSPM184534G	18" x 45"	Gray	4/cs
EVSPM243634B	24" x 36"	Blue	4/cs
EVSPM243634G	24" x 36"	Gray	4/cs
EVSPM264534W	26" x 45"	White	4/cs
EVSPM264534B	26" x 45"	Blue	4/cs
EVSPM264534G	26" x 45"	Gray	4/cs
EVSPM363634W	36" x 36"	White	4/cs
EVSPFM2531310	25" x 31"	White	1 ea



EVSPM184534W

# Floor Protectors

## Scuff-Free Floor Savers®

- Reduce the noise level in your facility where chairs and tables are frequently moved to accommodate daily activities
- Minimize maintenance costs by reducing damage and wear to flooring and furniture
- Prolong the appearance of the furniture
- Minimize the chance of furniture tipping over while an individual is seated

Item No.	Description	Size	Color	Pkg.
MPHF141B	Heavy-Duty Felt Pad	2.25" Square	Brown	100/cs
MPHFCS2B	Sleeve Floor Protector	0.63" to 0.75"	Clear	100/cs
MPHFCS3B	Sleeve Floor Protector	0.88" to 1.06"	Clear	100/cs
MPHFCS4B	Sleeve Floor Protector	1.12" to 1.25"	Clear	100/cs
MPHFCS5B	Sleeve Floor Protector	1.5" to 1.63"	Clear	100/cs
MPHFCS6B	Sleeve Floor Protector	1.63" to 1.75"	Clear	100/cs
MPHFCS7B	Sleeve Floor Protector	1.88" to 2"	Clear	100/cs
MPHFCS8B	Sleeve Floor Protector	2" to 2.13"	Clear	100/cs
MPHFCS9B	Sleeve Floor Protector	2.1" to 2.3"	Clear	100/cs
MPHFCS10B	Sleeve Floor Protector	2.3" to 2.4"	Clear	100/cs
MPHFFF3B	Form Felt Floor Protector	1" Round	Brown	100/cs
MPHFFF5B	Form Felt Floor Protector	1.25" Round	Brown	100/cs
MPHFFF7B	Form Felt Floor Protector	1.5" Round	Brown	100/cs
MPHFFF8B	Form Felt Floor Protector	2" Round	Brown	100/cs
MPHF018020	Chair Tip Floor Protector	0.88" Round	Gray	100/cs
MPHF018021	Chair Tip Floor Protector	1" Round	Gray	100/cs
MPHF018037	Walker Tip Floor Protector	1.12" Round	Black	100/cs
MPHF133B	Slip-On Floor Protector	1.25" Round	Gray	100/cs
MPHF134B	Slip-On Floor Protector	1.5" Round	Gray	100/cs
MPHF135B	Slip-On Floor Protector	1.25" Round	Brown	100/cs
MPHF136B	Slip-On Floor Protector	1.5" Round	Brown	100/cs
MPHF137B	Slip-Over Floor Protector	1.25" Round	Gray	100/cs
MPHF138B	Slip-Over Floor Protector	1.5" Round	Gray	100/cs
MPHF13224	Slider	3.5" x 4.5"	Gray	16/cs
MPHF411B	Caster Floor Protector	0.38" x 1.75"	Gray	100/cs
MPHFWRAPGYLGB	Wraparound Floor Maintainer	1.8" x 3.1"	Gray	100/cs
MPHF01606424P	Door Wedge	2.25"D x 1.25"H x 3"W	Blue	24/cs



MPHF13224



MPHF133B



MPHFWRAPG4LGB



MPHF411B



MPHFCS5B



MPHF01606424P

## Floor Safe Caster

- **Floor safe**—Polyurethane construction reduces risk of scuff marks on most hard floor surfaces
- **Quiet**—For patient satisfaction
- **Promote rest and comfort**—Noise reduction may help improve patient satisfaction
- **Universal fit**—Designed to fit most nurse station and office chairs
- **Specifications**—Wheel diameter: 3"; stem diameter: 7/16"; stem length: .87"; weight capacity: 200 lb

Item No.	Description	Pkg.
MPHFCASTERS	Healthcare Chair Caster	5/bx



MPHFCASTERS

# Floor Pads

## Rethink your floor care from the ground up

### Do I have the right floor care routine in place?

To clean, protect and prolong the life of your floors, they need the right care at the right time—and frequency is everything. There are **four** traditional floor care procedures:

#### Buffing and Polishing

- Removes embed dirt and soil from a floor surface and refreshing the shine
- **Frequency: daily/routine use**



#### Burnishing

- Smooths away scratches that could capture dirt and pops shine
- **Frequency: 3x a week**



#### Scrubbing and Cleaning

- Removes embedded dirt and soil from top layers of floor surface without stripping
- **Frequency: weekly/bi-weekly**







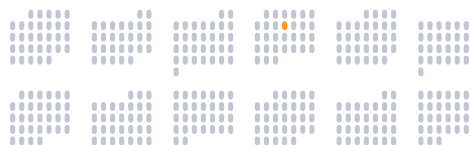

#### Stripping

- Removes layers of finish or sealer from the floor surface
- **Frequency: restorative**



### Not sure which floor pads to use with your machine?

Use this key to match the right floor machine for best results.

- |   |  |
|---|--|
|  Standard Electric         |  Automatic Scrubber |
|  Ultra-High Speed Electric |  Oscillating        |
|  Ultra-High-Speed Propane  |  |
|  Ultra-High-Speed Battery  |  |

Contact your Medline Representative for additional sizes or questions about floor care.

# Floor Pads

## Buffing and Polishing Pads

### Low-Speed Buffing Pads



- For daily cleaning and buffing
- Remove light scuff marks and dirt while producing a high-gloss shine
- Machine speed: up to 800 RPM

Item No.	Size	Color	Pkg.
EVSPBUFF20R	20"	Red	5/cs
EVSPBUFF19R	19"	Red	5/cs
EVSPBUFF17R	17"	Red	5/cs
EVSPBUFF15R	15"	Red	5/cs
EVSPBUFF13R	13"	Red	5/cs
EVSPSBUF1420	14" x 20"	Red	5/cs



EVSPBUFF20R



EVSPBUFF1420

### High-Speed Polishing Pads



- Extra-fine pad for polishing clean, dry floors
- For buffing soft finishes and low-traffic areas
- Ideal for marble floors
- Machine speed: up to 3,000 RPM

Item No.	Size	Color	Pkg.
EVSPPLSH20W	20"	White	5/cs
EVSPPLSH19W	19"	White	5/cs
EVSPPLSH17W	17"	White	5/cs
EVSPPLSH15W	15"	White	5/cs
EVSPPLSH13W	13"	White	5/cs
EVSPSPLSH1420	14" x 20"	White	5/cs



EVSPPLSH20W



EVSPSPLSH1420

### Clean and Shine Floor Pads



- Chemical-free, works with just water
- Versatile, can be used on most flooring substrates
- Labor saving, reduces/eliminates need to burnish
- Lasts 5x longer than traditional floor pad

Item No.	Size	Color	Pkg.
EVSPCLNSHN20L	20"	Green/Yellow	5/cs
EVSPCLNSHN142	14" x 20"	Green/Yellow	5/cs



EVSPCLNSHN20L

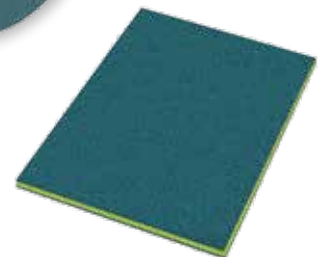

EVSPCLNSHN142

# Floor Pads

## Ultra High-Speed Burnishing Pads

### High-Speed Burnishing Pads



- UHS burnishing pad blended polyester and natural fibers for an extra-high gloss when buffing
- For use on machines up to 3,000 RPM
- Floor finish hardness is based on how much polymer is in the finish

Item No.	Size	Color	Pkg.
<b>Blue</b> —Frequent burnishing on soft finishes			
EVSPBURN27BL	27"	Blue	5/cs
EVSPBURN20BL	20"	Blue	5/cs
<b>Aqua</b> —Frequent burnishing on soft to medium finishes			
EVSPBURN20A	20"	Aqua	5/cs
<b>Tan</b> —Frequent burnishing on soft to medium-hard finishes			
EVSPBURN20T	20"	Tan	5/cs
EVSPBURN19T	19"	Tan	5/cs
<b>Pink</b> —Removes black marks and restores gloss on medium to hard finishes			
EVSPBURN27PK	27"	Pink	5/cs
EVSPBURN20PK	20"	Pink	5/cs
<b>Natural</b> —Natural fiber for minimal burnishing on hard finishes			
EVSPBURN20HA	20"	Natural Fiber	5/cs
EVSPBURN19HA	19"	Natural Fiber	5/cs



EVSPBURN20A



EVSPBURN20T



EVSPBURN20PK



EVSPBURN20HA

## Scrubbing and Cleaning Pads

### Low-Speed Scrubbing Pads



- For heavy-duty scrubbing or light stripping
- Removes heavy dirt and scuff marks prior to recoating
- Machine speed: up to 350 RPM

Item No.	Size	Color	Pkg.
EVSPSCRUB20G	20"	Green	5/cs
EVSPSCRUB17G	17"	Green	5/cs
EVSPSCRUB13G	13"	Green	5/cs
EVSPSSCRB1420	14" x 20"	Green	5/cs



EVSPSCRUB20G

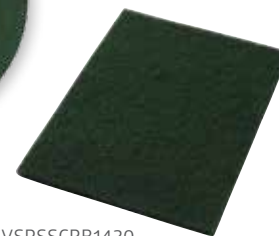

EVSPSSCRB1420

### Low-Speed Buffing Pads



- For standard wet scrubbing and deep cleaning without removing finish
- Removes dirt and scuff marks prior to recoating
- Machine speed: up to 350 RPM

Item No.	Size	Color	Pkg.
EVSPCLEAN20B	20"	Blue	5/cs
EVSPCLEAN19B	19"	Blue	5/cs
EVSPCLEAN17B	17"	Blue	5/cs
EVSPSCLN1420	14" x 20"	Blue	5/cs



EVSPCLEAN20B



EVSPSCLN1420

# Floor Pads

## Stripping Pads

### Extra Heavy-Duty Stripping Pads

- Most aggressive pad for extreme stripping tasks
- Increased abrasive content with extra-heavy denier fiber
- Machine speed up to 350 RPM

Item No.	Size	Color	Pkg.
EVSPSTRP13BK	13"	Black	5/cs
EVSPSSTRP1420	14" x 20"	Black	5/cs
EVSPSTRP17BK	17"	Black	5/cs
EVSPSTRP19BK	19" x 20"	Black	5/cs
EVSPSTRP20BK	20"	Black	5/cs



### Low-Speed Stripping Pads

- Standard pad for normal stripping
- Removes wax, dirt and old finish
- Machine speed up to 350 RPM

Item No.	Size	Color	Pkg.
EVSPHYPRO17M	17"	Maroon	5/cs
EVSPHYPRO19M	19"	Maroon	5/cs
EVSPHYPRO20M	20"	Maroon	5/cs



### Eco-Prep Pads

- Designed to strip floors without use of hard chemicals
- For wet or dry stripping and deep scrubbing
- Machine speed up to 300 RPM

Item No.	Size	Color	Pkg.
EVSPSFP1420	14" x 20"	Maroon	10/cs
EVSPSFP17M	17"	Maroon	10/cs
EVSPSFP20M	20"	Maroon	10/cs



# Scrubbers

## Nilfisk Wall-Behind Scrubber

- High-capacity 16-gallon solution and recovery tanks with working width of 20"
- Convenient on-board battery charger
- Includes traction drive and pad driver
- 31" squeegee assembly
- 10 amp on board charger, 140 A/H AGM batteries

Item No.	Description	Size	Ship Wt.	Pkg.
NIL56384815	Disc Scrubber	20"	491 lb	1 ea



NIL56384815

## BD 50/50 Walk-Behind Floor Scrubber

- Three cleaning modes make it easy to operate
- Slim design with 20" cleaning path
- 13.2 gallon solution/recovery tanks
- Easy access to batteries; battery type: AGM

Item No.	Description	Size	Ship Wt.	Pkg.
KNA98413700	20" with Pad Driver	47" x 21" x 39"	306 lb	1 ea



KNA98413700

## Nilfisk Wall-Behind Micro-Scrubber

- Designed for scrubbing and drying mid-sized and high-traffic areas
- Powerful, compact and easy to operate
- Ideal for hospitals, schools and other institutions

Item No.	Description	Pkg.
NIL9087342020	SC351 AGM	1 ea



NIL9087342020

# Floor Machines

## Nilfisk Low-Speed Floor Machine

- Functions only when the operator is ready, with safety interlock triggers and upright lock-out
- Quiet, with noise levels less than 58 dBA
- “Safe start” indicator helps keep the operator in control during startup
- Easy handle adjustments from the operator position, with no knobs or awkward levers

Item No.	Description	Ship Wt.	Size	Pkg.
NILVN2015	20" Disk, 175 RPM	98 lb	26" x 21" x 45"	1 ea



NILVN2015

## Advance Orbital Floor Machines

- Get cleaner floors in fewer passes during wet and dry applications
- Versatile and easy to use
- 1.5 horsepower motor helps get floors clean or stripped quickly

Item No.	Description	Ship Wt.	Size	Pkg.
NIL56105616	14" x 20", FM810XP	169 lb	20" x 20.5" x 44"	1 ea
NIL56105614	14" x 20", 3,540 RPM	161 lb	20" x 20.5" x 44"	1 ea



NIL56105616

**Need more options?** Contact your Medline Representative to learn about other equipment offerings.

# Burnishers

## Venom VN1500 Burnisher

- Burnisher with 1,500 RPM and 20" cleaning path
- Easy to use and maneuver with flexible pad driver and large wheels for easy transporting

Item No.	Description	Ship Wt.	Size	Pkg.
NILVN1500	Viper Burnisher, 500 RPM, 20"	102 lb	35" x 20" x 48"	1 ea



## High-RPM Cord-Electric Burnisher

- 1,500 RPM delivering pad tip speeds over 7,850 ft/min, for a reflective finish
- Easy handle adjustments from the operator position, with no knobs or awkward levers
- Functions only when the operator is ready, with safety interlock triggers and upright lock-out
- Unique wraparound cord clamp

Item No.	Description	Ship Wt.	Size	Pkg.
EVSM20H	1,500 RPM, 20"	79 lb	37" x 21" x 47"	1 ea



## Stand-On Burnisher

- Compact, stand-on floor burnishers with small footprint and high mobility for use in tight, busy areas
- Low dBA for use during daytime or in noise-sensitive areas
- Spring-loaded, weighted pad reduce time spent adjusting; simply turn the dial and burnish
- Intuitive controls for easy training and operating
- Tie-down bar for easy transportation

Item No.	Description	Pkg.
KNA981410880	Chariot 2 iGloos 20	1 ea



# Air Blowers

## Three-Speed Air Mover

- Three-speed induction motor with thermal protection for 2,400 CFM air flow with minimal energy use
- Quickly dries floors and circulates air

Item No.	Description	Pkg.
NIL50000390	Three-Speed Air Mover	1 ea
NILVV78406	Trolley Kit	1 ea



NIL50000390

## Bissell Air Blower

- Cordless floor-drying cone dolly provides 360-degrees of continuous airflow, up to 15 feet in diameter
- Yellow cone helps warn of potential safety hazards
- Runs 8 hours on a rechargeable battery

Item No.	Description	Pkg.
BCHURRICONE	Hurricane Battery-Operated Floor Dryer and Safety Cone, 36"H	1 ea



BCHURRICONE

## Karcher Air Blower

- Powerful fast-drying radial fan
- Tough plastic housing with handy power cord storage
- Built-in carpet clip makes drying loosely laid carpets a breeze
- Extra-large wheels for easy transport
- Compact design with foldable handle

Item No.	Description	Pkg.
KNA10040390	Air Blower, 3 Speed	1 ea



KNA10040390

# Extractors

## Karcher Walk-Behind Carpet Extractor

- Mid-size, 12-gal carpet extractor
- Flip handle for push or pull operation to increase extraction productivity

Item No.	Description	Ship Wt.	Size	Pkg.
KNA10080250	12-gal Clipper, 18" Carpet Extractor	105 lb	28" x 23" x 46"	1 ea



KNA10080250

## Commercial Extraction Cleaner

- Compact and powerful for cleaning small areas
- Easy to use and transport
- 8' solution and recovery hose and hand tool

Item No.	Description	Ship Wt.	Size	Pkg.
KNA11001330	8/1C Commercial Carpet Extractor	23.5 lb	27.2" x 12.8" x 17.3"	1 ea



KNA11001330

## Walk-Behind Carpet Extractor

- Helps remove deeply embedded dirt from high-traffic areas
- Easy to operate
- Superior suction for excellent cleaning results

Item No.	Description	Ship Wt.	Size	Pkg.
NIL5000545	9-gal Solution Tank	100 lb	18" x 41" x 47"	1 ea



NIL5000545

# Vacuums

## Nilfisk Upright Vacuum

- Low profile, adjustable handle, onboard tools and HEPA filter included
- Upright vacuum with handle placed to help reduce need to bend over during operation
- Suction at cleaning head loosens and lifts embedded dirt
- Convenient collection for easy disposal

Item No.	Description	Pkg.
NIL107404753	12" V500 Single-Motor Upright Vacuum	1 ea
NIL107413586	Vacuum Bag	10/bx
NIL1471250600	HEPA Filter	1 ea

NIL107404753



## Bissell Upright Vacuum Cleaner

- Can clean a variety of surfaces from bare floors to high carpets and upholstered furniture
- Powerful suction with cyclonic cleaning system

Item No.	Description	Pkg.
BCBGU1937T	13" Bagless Commercial Upright Vacuum	1 ea

BCBGU1937T



## Sensor S2 Upright Vacuums

- Extremely quiet—only 67 dBA for cleaning in noise-sensitive areas
- Reliable—no worn-out swivels or connectors as all electronics are housed in the base
- Improved indoor air quality—HEPA final stage filtration, standard

Item No.	Description	Pkg.
KNA1012070	12" Sensor S2 Vacuum	1 ea
KNA10120710	14" Sensor S2 Vacuum	1 ea
KNA8600050	Bags for Sensor S2	10/cs

KNA1012070



## Sensor XP Upright Vacuums

- Automatic brush-height adjustment ensures optimum cleaning performance
- Efficiently removes soils that could ruin carpets and hard floors, saving you time and money
- Comes standard with a high-efficiency filter
- Ultra-light handle weight lessens operator fatigue while increasing productivity
- Flat-to-floor feature allows vacuum to easily clean under beds and furniture for added convenience

KNA10120300

Item No.	Description	Pkg.
KNA10126110	12" Sensor XP Vacuum	1 ea
KNA10126120	15" Sensor XP Vacuum	1 ea
KNA10120300	18" Sensor XP Vacuum	1 ea
KNA8600050	Bags for Sensor XP	10/cs



# Vacuums

## Nilfisk Upright Vacuum

- Vacuum with integrated handle helps reduce need to bend over during operation
- Suction at cleaning head loosens and lifts embedded dirt
- Convenient collection for easy disposal
- Brush has eight height settings for various carpet piles
- Built-in hose 14" (stretches 56", wand is 24"), 75-foot power cord

Item No.	Description	Pkg.
NIL56330020	28"-Wide Area Vacuum	1 ea



NIL56330020

## Karcher Wet/Dry Commercial Vacuum

- Good for wet and dry vacuuming of small areas
- Provides powerful suction performance
- Pick up dirt and liquid

Item No.	Description	Pkg.
KNA14286230	12-gal NT 48/1 Wet/Dry Vacuum	1 ea



KNA14286230

## Nilfisk Wet/Dry Vacuum

- 18-gal capacity
- 24" front-mount squeegee
- Includes a 5-pc contractor tool kit with crevice tool, dusting brush, wet and dry pick-up tools and a 3-pc stainless steel wand

Item No.	Description	Pkg.
NILSN18WD	18-gal Wet/Dry Vac	1 ea



NILSN18WD

# Sweepers

## Bissell Manual Sweeper

- Dual debris canisters are easy to empty and feature a handy viewing window
- Soft rubber wheels conform to a variety of floor surfaces
- Corner brushes for hard-to-reach areas
- Two rows of rubber rotors lift dirt fast
- Hand-friendly grip

Item No.	Description	Pkg.
BCBG21	9.5" Manual Sweeper	1 ea

BCBG21



## Karcher Cordless Electric EB 30/1 Sweeper

- Flat design enables it to reach beneath radiators and furniture with low ground clearance, allowing for more coverage
- Picks up loose dirt within just 2 mm of its edges for a more efficient cleaning job
- Telescopic broomstick has a push handle and can be adjusted to suit the operator's height, while a universal joint enables it to move in all directions
- No additional tools needed to change batteries or remove the roller brush

Item No.	Description	Pkg.
KNA15451210	12" Cordless Electric Sweeper, 30/1	1 ea

KNA15451210



## Karcher Radius Manual Walk-Behind Sweeper

- Compact, durable sweeper provides a fast and efficient way to clean halls, sidewalks, warehouses, etc.
- Both wheels drive the roller brush, so it continues to sweep well during turns
- Adjustable roller height
- Ergonomic handle
- Flat design for easy storage

Item No.	Description	Pkg.
KNA15171060	28" Radius Manual Walk-Behind Sweeper with Brushes	1 ea



KNA15171060

# Floor Mops

## Loop Mops

- Made in USA
- Fantail spread covers more floor per sweep, helping to reduce time and labor cost
- Poly-mesh headband dries quickly
- Use with jaw mop handle (EVSTOOL111F) or quick-change mop handle (EVSTOOL121P)

Item No.	Yarn Color	Size/Band Color	Pkg.
GSC72301	Natural	12 oz, Small/Yellow	12/cs
GSC72302	Natural	16 oz, Medium/Green	12/cs
GSC72303	Natural	24 oz, Large/Red	12/cs
GSC72501	Blue	12 oz, Small/Yellow	12/cs
GSC72502	Blue	16 oz, Medium/Green	12/cs
GSC72503	Blue	24 oz, Large/Red	12/cs
GSC72701	Orange	12 oz, Small/Yellow	12/cs
GSC72702	Orange	16 oz, Medium/Green	12/cs
GSC72703	Orange	24 oz, Large/Red	12/cs
GSC72601	Green	12 oz, Small/Yellow	12/cs
GSC72602	Green	16 oz, Medium/Green	12/cs
GSC72603	Green	24 oz, Large/Red	12/cs



## Rayon Mops

- Rayon-blend mop is ideal for when the highest cleaning standards are required
- Loop end construction prevents unraveling and limits fraying

Item No.	Description	Size	Pkg.
GSC71412	Rayon Loop Mop	Medium, 16 oz	12/cs
GSC60716	4-Ply Loop Mop	Medium, 16 oz	12/cs



## Disposable Economy White Mop

- Polyester/rayon material
- Absorbs seven times its weight
- Low-linting and lightweight
- Cut-end mop
- Narrow 1.25" headband

Item No.	Description	Pkg.
EVS67448	Disposable Economy Mop, White	12/cs



# Floor Mops



GSC212180



GSC201189, GSC201185



GSC25118

## BEST

### Premium Synthetic Dust Mops

- Dries quicker and saves energy
- Ideal for laundry facilities
- Maximum particle attraction
- Exceptional laundering quality
- Slot pocket for easy frame insertion

Item No.	Size	Color	Pkg.
GSC212180	5" x 18"	White	12/cs
GSC212240	5" x 24"	White	12/cs
GSC212360	5" x 36"	White	12/cs
GSC212480	5" x 48"	White	12/cs

## BETTER

### Premium Dust Mops

- Featuring a slot pocket for easy frame insertion
- Durable poly-twill yarn withstands repeated laundering

Item No.	Size	Color	Pkg.
GSC201185	5" x 18"	Blue	12/cs
GSC201245	5" x 24"	Blue	12/cs
GSC201365	5" x 36"	Blue	12/cs
GSC201485	5" x 48"	Blue	12/cs
GSC201189	5" x 18"	Red	12/cs
GSC201249	5" x 24"	Red	12/cs
GSC201369	5" x 36"	Red	12/cs
GSC201489	5" x 48"	Red	12/cs

## GOOD

### Economy Cotton Dust Mops

- A low-cost alternative
- Can be laundered without shrinking
- Durable, sewn construction
- Natural cotton yarn
- Polyester backing with keyhole ties

Item No.	Size	Color	Pkg.
GSC25118	5" x 18"	Natural	12/cs
GSC25124	5" x 24"	Natural	12/cs
GSC25136	5" x 36"	Natural	12/cs



GSC71213

### Premium Finishing Mops

- Made of a synthetic, twisted polyester/rayon blend to help reduce linting
- Looped ends and tail-bands help reduce streaking for a smooth application
- Blue and White striped yarn
- Narrow 1.25" headband

Item No.	Description	Pkg.
GSC71213	Premium Mop, Large, 24 oz	12/cs
GSC71212	Premium Mop, Medium, 16 oz	12/cs



GSC26518

### Dust Mop Wire Frames and Handle

- Wire frames available to fit a variety of mop sizes
- Clip-on wood handle works with most standard frames

Item No.	Description	Size	Pkg.
GSC26518	Dust Mop Wire Frame	5" x 18"	12/cs
GSC26524	Dust Mop Wire Frame	5" x 24"	12/cs
GSC26536	Dust Mop Wire Frame	5" x 36"	12/cs
GSC26548	Dust Mop Wire Frame	5" x 48"	12/cs
GSC26560	Dust Mop Wire Frame	5" x 60"	12/cs
GSC25555Z	Wooden Clip-On Dust Mop Handle	60"L	1 ea

**Microfiber**



# Microfiber Mops and Accessories

## Premium Scrubber Mops

- Low-nap Blue yarn with White microfiber inner liner
- Industrial-style hook and loop
- Dark Blue banding for extended laundering
- Scrubbing strips to enhance cleaning performance

Item No.	Size	Color	Pkg.
MDT217741B	20.5"	Blue	100/cs
MDT217741	20.5"	Blue	36/cs
MDT217741ORB	20.5"	Orange	100/cs



MDT217741ORB

MDT217741B

## Premium Micro-Fill Wet Mop

- For daily wet or damp cleaning of floors and walls
- Double layer of 100% split microfiber with a microfiber fill offering more durability than foam-filled alternatives
- Increased size to accommodate laundry customers
- Banding around the edge for increased durability
- Hook-and-loop construction for improved adherence to the mop frame and square corners to clean corners more efficiently

Item No.	Size	Color	Pkg.
MDT217766	20.5"	Blue	100/cs



MDT217766

## Premium Foam-Fill Wet Mop

- For daily wet or damp cleaning of floors and walls
- Double layer of 100% split microfiber with a foam fill for increased absorption and longevity
- Increased size to accommodate laundry customers
- Banding around the edge for increased durability
- Hook-and-loop construction for improved adherence to the mop frame

Item No.	Size	Color	Pkg.
MDT217620P	20.5"	Blue	100/cs



MDT217620P

### Micro-Fill Wet/Dry Mops

- For daily wet or damp cleaning of floors and walls
- Double layer of 100% split microfiber with a microfiber fill offering more durability than foam-filled alternatives
- Available with or without microfiber fringe sewn around the edges

Item No.	Size	Color	Pkg.
MDT217775	18"	Green	100/cs
MDT217771	18"	Green with Fringe	100/cs



MDT217775, MDT217771 (with fringe)

### Micro-Fill Wet/Dry Mop

- For daily wet or damp cleaning of floors and walls
- Double layer of 100% split microfiber with a microfiber fill offering more durability than foam-filled alternatives

Item No.	Size	Color	Pkg.
MDT217812	12"	Blue	36/cs



MDT217812

### Foam-Fill Wet Mops

- For daily wet or damp cleaning of floors and walls
- Double layer of 100% split microfiber with a foam fill for increased absorption and longevity
- Perfect for use with dust mop (MDT217630)

Item No.	Size	Edge	Color	Pkg.
MDT217619	18"	Stitched	Blue, with 5-Color Tab Coding	100/cs
MDT217620	18"	Stitched	Blue	100/cs
MDT217621	24"	Stitched	Blue	12/cs
MDT217622	36"	Stitched	Blue	12/cs
MDT217623	48"	Stitched	Blue	3/cs
MDT217625	18"	Banded	Blue	100/cs



MDT217619

# Microfiber Mops and Accessories

## Mop Buckets

- Holds up to twenty 18" (46 cm) microfiber mop heads
- Used for wetting or "charging" microfiber with cleaning solution
- 19"W x 10"H x 10"D (48 x 25 x 25 cm)

Item No.	Description	Color	Pkg.
MDTBUCKETBLU	Microfiber Bucket with Lid, 5 gal	Blue	1 ea
MDTBUCKETRED	Microfiber Bucket with Lid, 5 gal	Red	1 ea
IPESECC0015B	Mop Bucket, 6 gal	Blue	1 ea
IPESECC0019B	Lid for Blue Mop Bucket	Blue	1 ea
IPESECC0015Y	Mop Bucket, 6 gal	Yellow	1 ea
IPESECC0019Y	Lid for Yellow Mop Bucket	Yellow	1 ea



MDTBUCKETBLU

## Microfiber Starter Kit

- Ideal for facilities that want to try out the system or have a small area to clean

Item No.	Description	Pkg.
MICROINSKIT1	Microfiber Starter Kit, includes All Items Listed Below	1 ea

### Kit Contents:

Item No.	Description	Pkg.
MDT217610Z1	Mop Frame, 18" Non-Locking Mop Head	1 ea
MDT217605Z1	Telescoping Handle, 39" closed, 70" Extended	1 ea
MDT217620	Wet Mop, 18" Wet Mop, Blue	5/cs
MDT217630	Dust Mop, 18" Dust Mop, Green	5/cs
MDT217750	High Duster with Microfiber Sleeve	1 ea
MDTBUCKETBLU	Microfiber Bucket	1 ea
MDT217658	Glass Towel, 12" x 12", Blue	1 ea
MDT217647	Cleaning Cloth, 12" x 12", Blue	1 ea

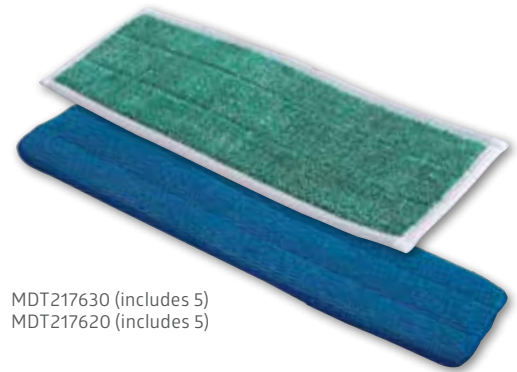
MDT217630 (includes 5)  
MDT217620 (includes 5)

## Advantage System Canister

- Provides optimal water to chemical measurement for each mop
- Bottle mouth minimizes spills and splashes

Item No.	Description	Pkg.
MDTCANISTER2	Microfiber Advantage System Canister	10/cs



MDTCANISTER2

# Microfiber Dusters

## Microfiber High Duster

- Can be used with telescoping mop handle
- Conforms to various surfaces and hard-to-reach spots for easy dust removal
- Traps dust particles without releasing them into the air on curtain tracks, ceiling fans, shelving and more

Item No.	Description	Pkg.
MDT217750	High Duster with Microfiber Sleeve	1 ea
MDT217751	High Duster Sleeve Replacement	10/cs
MDT217735	High Duster Hardware Only	50/cs



## Microfiber High Dusters with Fringe

- Traps dust particles and won't release them into the air
- Reach high and difficult-to-access spots

Item No.	Description	Pkg.
MDT217854	High Microfiber Duster with Fringe, Blue, with Sleeve	12/cs
MDT217857	High Microfiber Duster with Fringe, Blue, Starter Kit with Sleeve	10/cs
MDT217858	Replacement Wand Hardware	12/cs
MDT217859	Handle Extender	10/cs



# Microfiber Bonnet Pads

## Microfiber Slow-Speed Carpet Bonnet Pads

- Designed for bonnet-saturated carpet cleaning
- Used with slow-speed floor machines
- High-absorbency, reversible pads

Item No.	Size	Color	Pkg.
MDT217787	17" Diameter	Blue	1 ea
MDT217788	19" Diameter	Blue	1 ea
MDT217789	21" Diameter	Blue	1 ea



# Microfiber Traditional Mops

## Traditional Wet Mops

- A traditional mop design, but made of microfiber for better cleaning
- Fits standard mop handles, holders, frames and wringers
- Use with plastic jaw: EVSTOOL111F, and wet mop handle: EVSTOOL121P

Item No.	Size	Color	Pkg.
MDT217793	10 oz	Blue	6/cs
MDT217794	14 oz	Blue	6/cs
MDT217796	18 oz	Blue	6/cs



MDT217793

## Traditional Dry Loop Dust Mops

- Traditional mop with the benefits of microfiber
- Works with your existing wire frame and handle
- Canvas backing has ties and pockets for convenience
- Use with dust mop handle: GSC25555Z

Item No.	Size	Color	Pkg.
MDT217635	24"	Blue	6/cs
MDT217636	36"	Blue	3/cs
MDT217634WHT	18"	White	6/cs
MDT217635WHT	24"	White	6/cs



MDT217635

## Telescoping Mop Handles and Frames

- Made of lightweight aluminum to reduce worker strain
- Ergonomic handle; adjustable to worker's height
- Handles and frames sold separately

Item No.	Description	Size	Pkg.
MDT217605	Handle	39"-70"	25/cs
MDT217605Z1	Handle	39"-70"	1 ea
MDT217820	Handle	39"-70" with Lock	1 ea
MDT217737	Mop Frame	10"	48/cs
MDT217610	Mop Frame	18"	10/cs
MDT217610Z1	Mop Frame	18"	1 ea
MDT2176122	Mop Frame	24"	10/cs
MDT217712	Mop Frame	36"	1 ea
MDT217713	Mop Frame	48"	1 ea



MDT217610



MDT217605

# Microfiber Traditional Mops

## Touchless Mop Handle and Frame

- Remove mop pad in one swift hands-free motion
- Frame features a rotating swivel head for cleaning in tight spaces and under furniture
- Lightweight handle adjusts in height from 49" to 63"

Item No.	Description	Pkg.
MDTHANDLE1	Handle and Frame	1 ea



## Microfiber Bucketless Mop Systems

- The direct-dispensing design of these mops helps save labor time as well as cleaning solution and water use
- Direct application of cleaning solution is more efficient and hygienic

Item No.	Description	Pkg.
MDTHANDLE2	Includes a Mop Handle, Hook-and-Loop Mop Head, Mop Frame and Two 32-oz Solution Tanks	1 ea
MDTHANDLE3	Includes a Mop Handle, Wrap-Around Mop Head, Pocket Mop Frame and Two 32-oz Solution Tanks	1 ea



# Microfiber Cleaning Cloths

## Multi-surface Cleaning Cloths

- For wet or dry cleaning of all above-the-floor surfaces, such as countertops, bedside tables, etc.
- 100% split microfiber for extra durability
- Washable up to 160°F



MDT2176 series

Item No.	Size	Weight	Color	Pkg.
MDT217649	12" x 12"	Lightweight	Blue	250/cs
MDT217688	12" x 12"	Lightweight	Green	250/cs
MDT217637	12" x 12"	Lightweight	Orange	250/cs
MDT217639	12" x 12"	Lightweight	Purple	250/cs
MDT217643	12" x 12"	Heavyweight	Yellow	250/cs
MDT217647	12" x 12"	Heavyweight	Blue	250/cs
MDT217897	12" x 12"	Heavyweight	Orange	144/cs
MDT217840	12" x 12"	Heavyweight	Pink	144/cs
MDT217841	12" x 12"	Heavyweight	Red	400/cs
MDT217671	16" x 16"	Lightweight	Blue	250/cs
MDT217672	16" x 16"	Lightweight	Green	250/cs
MDT217673	16" x 16"	Lightweight	Orange	250/cs
MDT217674	16" x 16"	Lightweight	Purple	250/cs
MDT217616	16" x 16"	Heavyweight	Yellow	250/cs
MDT217645	16" x 16"	Heavyweight	Blue	250/cs
MDT217675	16" x 16"	Heavyweight	Dark Blue	200/cs
MDT217848	16" x 16"	Heavyweight	Green	250/cs
MDT217898	16" x 16"	Heavyweight	Orange	144/cs
MDT217846	16" x 16"	Heavyweight	Pink	200/cs
MDT217896	16" x 16"	Heavyweight	Purple	144/cs
MDT217847	16" x 16"	Heavyweight	Red	200/cs

## Reusable Clean by Sequence Microfiber Booklets

- Our numbered microfiber booklets ensure a separate cloth is used for each surface and no surface is missed
- Color-coded based on the specific area being cleaned

Item No.	Description	Pkg.
MDT217690	Blue, Patient Room	250/cs
MDT217691	Orange, Patient Bathroom	250/cs
MDT217692	Purple, Discharge	250/cs



MDT217690

MDT217691

## Glass Cloth

- For wet or dry glass cleaning
- 100% split microfiber with a special coating to prevent linting

Item No.	Size	Color	Pkg.
MDT217658	12" x 12"	Blue	250/cs



MDT217658

# Disposable Products



MDT217618



MDT217DISP



MDT217DISP1

## Microfiber Disposable Mops

- For one-time wet, dry or damp dusting and floor cleaning
- Use in isolation rooms, clean rooms, operating rooms

Item No.	Size	Pkg.
MDT217618	No Fill 18" Blue	100/cs
MDT217DISP	18" White	100/cs
MDT217DISP1	18" White	250/cs
MDT217DISP2	18" White with Scrubbing Strips	100/cs



MDT217DISP2

## Disposable Microfiber Cloths

- Ideal for daily dusting and damp cleaning
- Can be used with cleaning solutions

Item No.	Description	Pkg.
MDT217DC10	Disposable Microfiber Cloth, 25 cloths/bag, Kit with Tub	10 bg/cs
MDT217DC20	Disposable Microfiber Cloth, 25 cloths/bag, Refill	10 bg/cs
MDT217DC30	Disposable Non-Woven Cloth, Economy	3,000/cs



MDT217DC10

## Disposable Dry Wipes

- Simple and convenient refillable wipes-and-bucket system
- Simply put in your cleaning solution to create cleaning wipes

Item No.	Description	Pkg.
EVS70111R3	Dry Wipes Refill Roll Only, 12" x 12", 110 wipes/roll	6 rl/cs
EVS70111B	Dry Wipes Bucket Only	1 ea



EVS70111B

# Carts and Containers



# Custom Cart Covers



Providing the proper fit and coverage requires custom sizing your cart covers.

We've streamlined our ordering process to make it easier than ever to get the exact custom cart covers you need. Plus, they're built to last, with strong double-stitched reinforced vinyl and heavyweight nylon materials.

**You can create custom covers for virtually any equipment in your facility, including:**

- Polyvinyl Bulk Trucks
- Tilt Trucks (covers and liners)
- Housekeeping Carts
- Utility Carts
- Computer Carts
- Beds in storage
- ...and more

# 1 Choose your cover type



Vinyl pocket



Grommets for locking



Reject linen pouch with silk screen

## Standard Covers—available in nylon or vinyl to help protect the product

Standard covers have a single front flap that's fastened shut with either zippers or hook-and-loop closures. Also available without a flap.



Silk screening is available as a custom extra



### Easy-Grab Covers—convenient access and permanent protection

- Keep your linens covered at all times with Clear view vinyl window strips
- Vertical panels let you easily see what you're grabbing
- No flaps to close—linens are never left uncovered
- Vinyl can be wiped down with a disinfectant and Nylon can be laundered on 110° F–130° F and tumble dried low; do not autoclave

### Half-Cart Covers—for poly bulk trucks

- Only a 12" cover on the sides and back is needed to hold this durable cover in place—plus a full front flap to cover the opening

Options include:

- Hook-and-loop to secure the front flap to the cart
- Elastic corners for a more snug fit
- Silkscreen your logo on the flap to market your business



Easy access to linens



Removable window strips for trouble-free laundering. Easily replaced if damaged or lost.



Reinforced corners



Elastic corners available for a more snug fit

## 2 Select your material and cover

### Standard, Easy-grab Covers—420 Denier Nylon Color Options



420 denier nylon (Khaki)

### Standard Covers—600 Denier Nylon Color Options

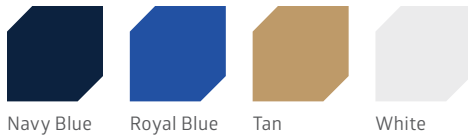

600 denier nylon (Royal Blue)

### Standard, Easy-grab Covers—11-oz Vinyl

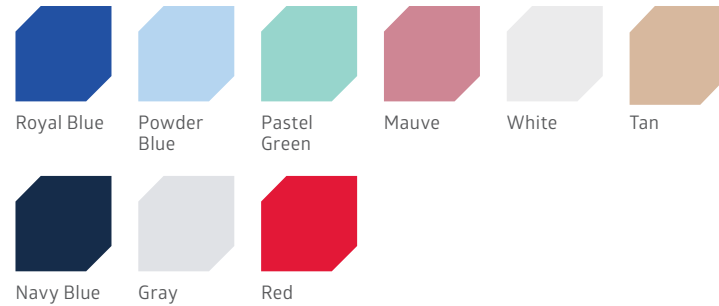

11-oz vinyl (Pastel Green)

Colors are reproduced as faithfully as the printing process allows. Please contact your Medline Representative for fabric samples to ensure satisfaction.

### 3 Measure your cart

Do not include casters when measuring height

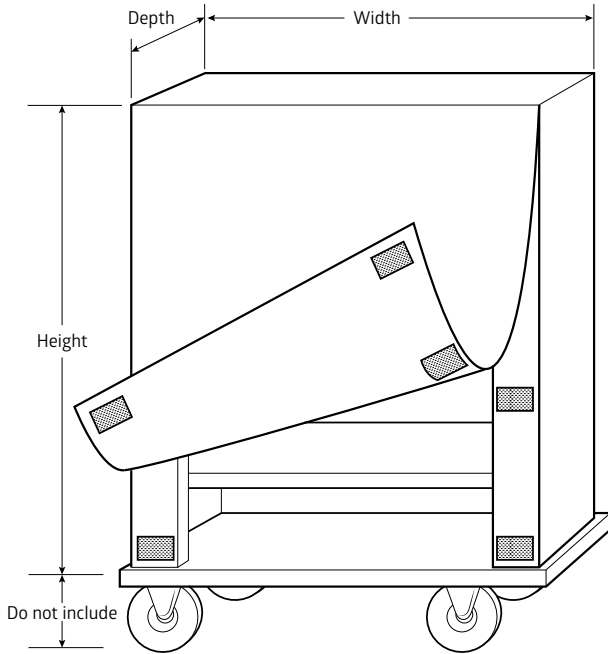

### 4 Indicate your closure type

For standard covers only



None



Zipper closure



Hook-and-loop closure

### 5 Add your extra options

Cutouts, pockets, graphics or windows can be located just about anywhere.

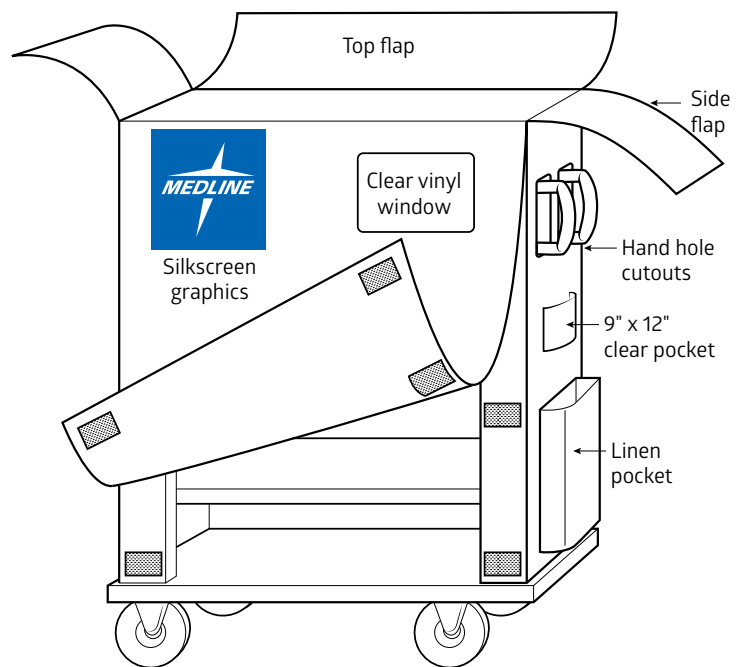

# Make It Your Own (MIYO) Housekeeping Carts

## Professional tools for high-level cleaning

Designed for healthcare, MIYO carts stand up to disinfectants, power washing and even autoclaving. Configure yours to have up to eight locking locations to help keep personal items, chemicals, supplies and trash secure. All carts include hanging tool kits and the accessories shown. Additional accessories are sold separately.

- Precisely engineered, durable copolymer components are quieter and lighter than metal carts
- Dome lids feature hydraulic pistons for silent closure
- Polymer casters swivel silently and provide maximum maneuverability
- Co-polymer, closed-cell material combined with rounded edges makes carts easy to clean and disinfect
- Sturdy, durable, lightweight and resistant to rusting and denting



### Patient Room: Lockable Single Supply Tower, Enclosed Trash

Item No.	Description	Pkg.
MPHMCPLUS5	44"H x 55"W x 22"D	1 ea

#### Accessories included in Hanging Tool Kit:

- One 4.25" hanging bar (dome)
- Two 5.5" hanging bars (bags)
- Four UNI-Move handle hangers



#### Locking Supply Tower

- One 6-gal, lockable sliding drawer with bottle organizer
- One 6-gal, non-locking sliding drawer

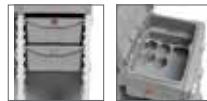

Lockable 40-gal enclosed trash compartment



### Patient Room: Lockable Single Supply Tower, Foldable Trash Bag

Item No.	Description	Pkg.
MPHMCE05	44"H x 39-55"W x 22"D	1 ea

#### Accessories included in Hanging Tool Kit:

- One 4.25" hanging bar (dome)
- One 4.25" hanging bar
- One 1" hanging bar
- Four UNI-Move handle hangers

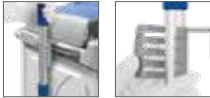

#### Locking Supply Tower

- One 6-gal, lockable sliding drawer with bottle organizer
- One 6-gal, non-locking sliding drawer

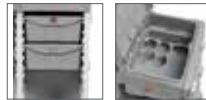

32-gal capacity trash bag includes a lid and collapses to reduce length from 55" to 39"



### Public Area: Lockable Single-Supply Tower, No Trash

Item No.	Description	Pkg.
MPHMC15	44"H x 46"W x 22"D	1 ea

#### Accessories included in Hanging Tool Kit:

- One 4.25" hanging bar (dome)
- One 4.25" hanging bar
- Four UNI-Move handle hangers



#### Locking Supply Tower

- One 3-gal non-locking sliding drawer
- One 6-gal, lockable sliding drawer
- One 6-gal, non-locking sliding drawer



Top-down charging bucket charges 30 mops in 30 minutes with 1.5-gal of solution



# MIYO Housekeeping Carts

## Operating Room: Single Supply Tower, No Trash

- **Antimicrobial treatment\* inhibits the growth of microorganisms causing stains, odor or product degradation**—Antimicrobial properties are built into the co-polymer material instead of being applied as a coating.

Item No.	Description	Pkg.
MPHMCAB1TW	44"H x 46"W x 22"D	1 ea

### Accessories included in Hanging Tool Kit:

- Four UNI-Move handle hangers



Four 6-gal, non-locking antimicrobial-treated\* sliding drawers

## Operating Room: Single Supply Tower, with Soiled Mop Bucket Collection, No Trash

- **Antimicrobial treatment\* inhibits the growth of microorganisms causing stains, odor or product degradation**—Antimicrobial properties are built into the co-polymer material instead of being applied as a coating.

Item No.	Description	Pkg.
MPHMCAB1TWRO	44"H x 46"W x 22"D	1 ea

### Accessories included in Hanging Tool Kit:

- Four UNI-Move handle hangers



### Soiled Mop Bucket Collection includes:

- 10"W side bucket that attaches to brackets
- Antimicrobial-treated\* top-down 5-gal bucket with red handle for collecting soiled mops
- Polyester mesh laundry bag with drawstring closure for easy transition to laundry

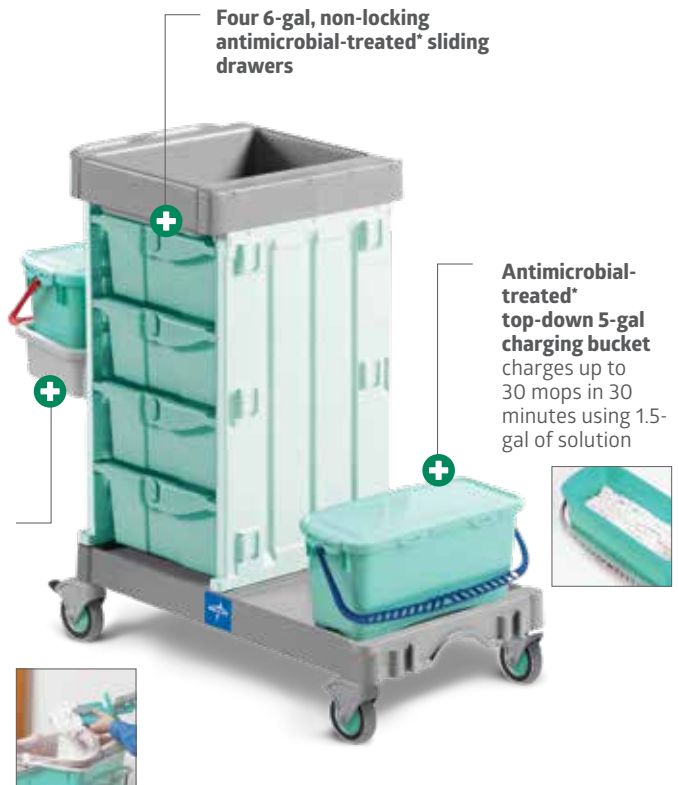

Four 6-gal, non-locking antimicrobial-treated\* sliding drawers

Antimicrobial-treated\* top-down 5-gal charging bucket charges up to 30 mops in 30 minutes using 1.5-gal of solution



\*This product has antimicrobial properties built in to protect the product. This product does not protect users or others against bacteria, viruses, germs or other disease organisms.

# MIYO Cart Accessories

## Base Extensions, Drawers and Shelves

Item No.	Description	Pkg.
MPHMCP515030	16.5" Base Extension with Two 5" Wheels	1 ea
MPHMCP075030U	12.5" Base Extension, One Non-Marking 5" Caster	1 ea
MPHMCP165000U	8.75" Microfiber Bucket Base Extension	1 ea
MPHMCP11911	10" Side Basket	1 ea
MPHMCP2191102	5" Side Basket	1 ea
MPHMCP1229909	Drawer without Lock, 3 gal	1 ea
MPHMCP2229909	Drawer with Lock, 3 gal	1 ea
MPHMCP1229906	Drawer without Lock, 6 gal	1 ea
MPHMCP2229906	Drawer with Lock, 6 gal	1 ea
MPHMC3691U	Caddy for Transporting Bottles/Supplies	1 ea
MPHMCP1229907	Drawer without Lock, 10.5 gal	1 ea
MPHMCP2229907	Drawer with Lock, 10.5 gal	1 ea
MPHMCP1229900	Set of 2 Shelves, 1/2"	2/cs
MPHMCP3229915	Multi-use Slide-out Tray	1 ea
MPHMCP1909937	Spray Bottle Holder	1 ea
MPHMCSM00250U	Uni-Move Handle Holder	1 ea
MPHMCP1919969	4.25" Hanging Bar	1 ea
MPHMCP1929969	5.5" Hanging Bar	1 ea
MPHMCP1909916	Universal Locking Key	1 ea



MPHMCP515030



MPHMCP075030U



MPHMCP165000U



MPHMCP11911



MPHMCP2191102



MPHMCP1229909



MPHMCP2229909



MPHMCP1229906



MPHMCP2229906



MPHMC3691U



MPHMCP1229907



MPHMCP2229907



MPHMCP1229900



MPHMCP3229915



MPHMCP1909937



MPHMCSM00250U



MPHMCP1919969



MPHMCP1909916



MPHMCP1929969

## Equidose® Mobile Microfiber Charging Accessories

Item No.	Description	Pkg.
MPHMCP311100U	Equidose Tank	1 ea
MPHMCP321101U	Equidose Tank with Viton Rubber Parts	1 ea
MPHMCP311200U	Equidose Microfiber Charging System, 2 Tanks, 1.5 gal	1 ea
MPHMCP321201U	Microfiber Bucket with Lid, 5 gal, Blue	1 ea
MPHMCSE3204	Bucket with Lid and Blue Handle, 1 gal.	1 ea



MPHMCP311100U



MPHMCP311200U



MPHMCSE3204

# MIYO Cart Accessories

## Charging Buckets

Item No.	Description	Pkg.
MDTBUCKETBLU	16" Top-Down Charging Bucket, with Gray Handle and Hermetic Cover, Blue, 5 gal	1 ea
MDTBUCKETRED	16" Top-Down Charging Bucket, with Gray Handle and Hermetic Cover, Red, 5 gal	1 ea
MPHMCSE0204UB	Microfiber Cloth Charging Bucket, 1 gal, Blue Handle	1 ea
MPHMCSE0204UR	Microfiber Cloth Charging Bucket, 1 gal, Red Handle	1 ea
MPHMCSE0204UY	Microfiber Cloth Charging Bucket, 1 gal, Yellow Handle	1 ea
MPHMCSE0204UG	Microfiber Cloth Charging Bucket, 1 gal, Green Handle	1 ea
MPHMCCP1205T	Hinged Plastic Cover Lid for 1-gal Bucket, White	1 ea



MDTBUCKETBLU



MDTBUCKETRED



MPHMCSE0204UB



MPHMCSE0204UR



MPHMCSE0204UY



MPHMCSE0204UG



MPHMCCP1205T

## OneFred Double Bucket Cart

- 24-oz Down Press Wringer, removable carry-all basket and two-6.5 gal bucket

Item No.	Description	Pkg.
MPHMCLF0536	Double Bucket Cart with Down Press Wringer and Basket	1 ea



MPHMCLF0536

## Alpha On Board® Double Bucket Combo

- 32 qt./8 gal and two 4-gal buckets with Punto Roller Wringer and two 4-gal buckets

Item No.	Description	Pkg.
MPHMCKIT008	Double Bucket Combo with Punto Wringer	1 ea



MPHMCKIT008

## Alpha On Board® Double Bucket Combo

- 332 qt./8 gal and two 4-gal buckets with extra capacity Down Press Wringer and two 4-gal buckets

Item No.	Description	Pkg.
MPHMCKIT012	Double Bucket with XL Down Press, 8 Gal, Blue	1 ea



MPHMCKIT012

# Cleaning Carts



## High Security Cleaning Cart

- Features a locking hood and storage compartment for extra security
- Spacious interior for collecting laundry or refuse; one standard bag included
- Non-marring bumper reduces costly wall damage
- Four-sided long-handle tool storage doubles as a hanging rack for spray bottles
- Handle folds up to help reduce space when cart is not in use

### Additional features include:

- Lockable hood
- Large bin
- Small bin (2-pack)
- Lockable front door
- Back panel
- Sign hooks
- Charging bucket wire
- 2 rollers/wall glides

Item No.	Description	Pkg.
EVSCART250	44.25"L x 23.25"W x 19.25"H	1 ea
EVSCBAG05D	Standard Bag, Black (Replacement)	1 ea

# Cleaning Carts



EVSCART2000



EVSCARTHOOD



EVSCBMDOOR

## Premium Housekeeping Cart

- Three non-marring rollers fixed on all four corners and impact-absorbing bumpers are spring-loaded to reduce costly wall damage
- 360° adjustable caster system increases maneuverability around tight corners and narrow hallways
- Long-handle tool storage on all four sides
- Holder also doubles as hanging rack for spray bottles
- Comes with 1 standard black bag; all other doors and hood sold separately

Item No.	Size	Pkg.
EVSCART2000	Premium Housekeeping Cart without Doors, Black	1 ea
EVSCBMDOOR	Suncart Door Kit, Black	1 ea
EVSCBAG05D	Suncart Standard Bag, Black	1 ea
EVSCARTHOOD	Hood, Black	1 ea



EVSCBAG05D

# Utility and Serving Carts

## Two-Shelf Heavy-Duty Utility Carts

- Sturdy multipurpose carts smoothly carry loads
- Shelf lip on all sides to help keep cart contents secure
- Features an ergonomically molded handle and four casters for easy maneuverability

Item No.	Description	Material	Size	Color	Pkg.
EVSC11BLKXL	Two-Shelf Cart Tub, 5" Lip	Poly	24.5" x 45.5"	Black	1 ea
EVSCEC11SP5B	Two-Shelf Cart Tub, 2.5" Lip	Poly	35.25" x 18"	Black	1 ea



EVSCEC11SP5B

## Two-Shelf Carts

- Polyethylene shelves and legs resist stains, scratches, dents and rust
- Push handle is molded into the top tub shelf
- Four 4" casters, two with locking brake

Item No.	Description	Material	Size	Color	Pkg.
EVSHE32BLK	Two-Shelf Cart, Flat	Poly	24" x 18"	Black	1 ea
EVSHE38BLK	Two-Shelf Cart, Flat	Poly	32" x 24"	Black	1 ea



EVSHE32BLK

## Three-Shelf Carts

- Polyethylene shelves and legs resist stains, scratches, dents and rust
- Push handle is molded into the top tub shelf
- Four 4" casters, two with locking brake

Item No.	Description	Material	Size	Color	Pkg.
EVSBUSTC111BL	Three-Shelf Cart, Flat	Poly	24" x 18"	Blue	1 ea
EVSHE34GRY	Three-Shelf Cart, Flat	Poly	24" x 18"	Gray	1 ea
EVSHE42BLK	Three-Shelf Cart, Flat	Poly	24" x 18"	Black	1 ea
EVSSTC111BLK	Three-Shelf Cart, Tub	Poly	24" x 18"	Black	1 ea
EVSSTC111GRY	Three-Shelf Cart, Tub	Poly	24" x 18"	Gray	1 ea



EVSSTC111BLK

# Utility and Serving Carts

## Three-Shelf Stainless Steel Utility Cart

- Satin-finished, durable, stainless steel, welded construction
- Platform folds up for compact storage
- Locking device holds platform securely in place

Item No.	Description	Material	Size	Color	Pkg.
EVSL100S3	Three-Shelf Cart	Stainless	26" x 16"	Silver	1 ea



EVSL100S3

Top  
seller

## Three-Shelf Serving Carts

- Multipurpose cart is ideal for a variety of applications
- Polypropylene shelves resist scratches, chips and dents and have a 1" lip on all sides to help keep cart contents secure
- Lightweight aluminum uprights provide stacking strength
- Ergonomic push handle on both sides for versatility and easy maneuverability; rolls on four 4"-dia. PVC casters

Item No.	Description	Material	Size	Color	Pkg.
EVSSC12BLK	Three-Shelf Cart	Poly	33.5"W x 16.75"D x 36.75"H	Black	1 ea
EVSSC12BG	Three-Shelf Cart	Poly	37.25"W x 19.75"D x 40.5"H	Gray	1 ea



EVSSC12BLK

## Large Three-Shelf Serving Cart

- Designed for maximum storage and weight capacity
- Durable polypropylene shelves resist dents and scratches
- Easy to maneuver with 4" PVC casters
- Shelves are spaced 12" apart for easy loading and unloading
- Shelves include a 1" lip on both sides and the back to help control contents

Item No.	Description	Material	Size	Color	Pkg.
EVSSC13G	Three-Shelf Cart	Poly	37.25"W x 19.75"D x 40.5"H	Gray	1 ea



EVSSC13G

# Surface Cleaning, Chemicals and Disinfectants



# Micro-Kill® Bleach Germicidal Bleach Wipes

EPA-registered product kills *Clostridium difficile* spores in 3 minutes\* and *Candida auris* in 2 minutes\*

One-step cleaner and disinfectant with sporicidal activity against *Clostridium difficile* spores.

Pre-moistened with solution equivalent to 1:10 dilution of 6.5% bleach

### Common uses

For disinfection of glucose meters\*\*, patient-care equipment, point-of-care equipment and hard, non-porous healthcare surfaces. See product label for specific instructions for use.

### Ordering information

Item No.	Description	Pkg.
MSC351400AN	7" x 8" Wipes, 150-Count Canister	8/cs
MSC351410AN	6" x 5" Wipes, 150-Count Canister	6/cs
MSC351450AN	12" x 12" Wipes, 110-Count Bag, Starter Kit: 4 bags/cs + 1 Bucket	1 kit
MSC351450BG4	12" x 12" Wipes, 110-Count Bag	4/cs
MSC351450ANB	Bucket Only	1 ea



MSC351450AN, MSC351400AN, MSC351410AN

Overall  
contact  
time of3  
min.<sup>†</sup>**Micro-Kill Bleach Wipes contact times\***

Contact time for a disinfectant is the amount of time a surface must remain wet with the product to achieve disinfection

Micro-organism	Contact time
<i>Acinetobacter baumannii</i> , MDR	30 seconds
Adenovirus Type 5	30 seconds
<i>Bordetella pertussis</i>	30 seconds
<i>Campylobacter jejuni</i>	30 seconds
<i>Candida albicans</i>	1 minute
<i>Candida auris</i>	2 minutes
<i>Clostridium difficile</i> spores	3 minutes
Coronavirus, Human	30 seconds
Coronavirus, SARS2-related (SARS-CoV-2)	30 seconds
Cytomegalovirus	30 seconds
<i>Enterobacter aerogenes</i>	30 seconds
<i>Enterobacter cloacae</i>	30 seconds
<i>Enterococcus faecalis</i> , Vancomycin-Resistant (VRE)	30 seconds
<i>Enterococcus faecium</i> , MDR	30 seconds
Enterovirus D68	30 seconds
<i>Escherichia coli</i>	30 seconds
<i>Escherichia coli</i> , O157:H7	30 seconds
<i>Escherichia coli</i> , ESBL	30 seconds
<i>Escherichia coli</i> , NDM-1	30 seconds
Hepatitis A Virus, (HAV)	30 seconds
Hepatitis B Virus, (HBV)	30 seconds
Hepatitis C Virus, (HCV)	30 seconds
Herpes Simplex Virus, Type 2 (HSV-2)	30 seconds
Human Immunodeficiency Virus, Type 1 (HIV-1) (AIDS Virus)	30 seconds
Influenza A Virus, (H1N1)	30 seconds
Influenza A Virus, (H3N2) Avian	30 seconds
Influenza A Virus, (H5N1) Avian	30 seconds
Influenza A Virus, (H7N9) Avian	30 seconds
Influenza A Virus	30 seconds
Influenza B Virus	30 seconds
<i>Klebsiella pneumoniae</i>	30 seconds
<i>Klebsiella pneumoniae</i> , Carbapenem-Resistant (CRKP) (CRE)	30 seconds

Micro-organism	Contact time
<i>Klebsiella pneumoniae</i> , ESBL	30 seconds
<i>Klebsiella pneumoniae</i> , NDM-1	30 seconds
<i>Legionella pneumophila</i>	30 seconds
<i>Listeria monocytogenes</i>	30 seconds
<i>Neisseria gonorrhoeae</i>	30 seconds
Norwalk Virus, (Norovirus)	30 seconds
Poliovirus (Type 1)	30 seconds
<i>Proteus mirabilis</i>	30 seconds
<i>Pseudomonas aeruginosa</i>	30 seconds
Respiratory Syncytial Virus (RSV)	30 seconds
Rhinovirus (Type 37)	30 seconds
Rotavirus	30 seconds
<i>Salmonella enterica</i>	30 seconds
<i>Serratia marcescens</i>	30 seconds
<i>Shigella dysenteriae</i>	30 seconds
<i>Staphylococcus aureus</i>	30 seconds
<i>Staphylococcus aureus</i> , Community Acquired—Methicillin Resistant (CA-MRSA)	30 seconds
<i>Staphylococcus aureus</i> , Linezolid-Resistant (LRSA)	30 seconds
<i>Staphylococcus aureus</i> , Methicillin-Resistant (MRSA)	30 seconds
<i>Staphylococcus aureus</i> , Vancomycin Intermediate-Resistant (VISA)	30 seconds
<i>Staphylococcus aureus</i> , Vancomycin-Resistant (VRSA)	30 seconds
<i>Streptococcus pneumoniae</i>	30 seconds
<i>Streptococcus pyogenes</i> , associated with scarlet fever	30 seconds
<i>Trichopyton interdigitale</i> (formerly <i>T. mentagrophytes</i> ) (Organism that causes Athlete's Foot Fungus)	1 minute
Vaccinia Virus (Strain WR)	30 seconds
Bovine Diarrhea Virus ‡	30 seconds
Canine Parvovirus ‡	30 seconds
Duck Hepatitis B Virus ‡	30 seconds
Feline Calicivirus ‡	30 seconds
Feline Panleukopenia Virus - (Feline Parvovirus) ‡	30 seconds

EPA Reg. No. 37549-1

<sup>^</sup>A pre-cleaning step is required for efficacy against +HIV, +HBV, +HCV, *Candida auris*<sup>\*\*\*</sup>, and *Clostridium difficile* spores<sup>\*\*\*\*</sup>.

<sup>\*</sup> Ensure that the hard, non-porous surface remains wet for the entire contact time.

<sup>\*\*</sup>This product is for the exterior surfaces of glucose meters and is not for use on the needle and/or monitors.

<sup>\*\*\*</sup>Follow the Special Instructions for Cleaning prior to disinfection for *Candida auris*.

<sup>\*\*\*\*</sup>Follow the Special Instructions for Cleaning prior to disinfection for *Clostridium difficile* spores.

<sup>†</sup> See Master Label EPA Reg. 37549-1 for complete list of micro-organisms and contact times.

<sup>‡</sup> Animal pathogen.

# Medline Micro-Kill® One Germicidal Alcohol Wipes

Quat/Alcohol

Effective in one minute\*

Contact time of

**1**  
min.†

## Kills TB, Norovirus, Rotavirus Strain WA and Rhinovirus in one minute

Micro-Kill One is a disinfecting wipe for hard, non-porous surfaces, patient care equipment and point-of-care equipment that features a quaternary ammonium and alcohol solution. It contains ethyl alcohol and quaternary ammonium compounds.

- One-step clean and disinfect for hard non-porous surfaces
- Bactericidal, tuberculocidal, fungicidal and virucidal

## Ordering information

Item No.	Description	Pkg.
MSC351300	6" x 6.75" Wipes, 160-Count Canister	12/cs
MSC351310	7.5" x 15" Wipes, 65-Count Canister	12/cs



MSC351310



MSC351300



## Common uses

For use on hard, non-porous surfaces only, including medical and dental surfaces, countertops, exam tables, carts, patient care equipment, point-of-care equipment, telephones, sinks, toilet seats, glazed porcelain, stainless steel, Formica®, vinyl and most plastic surfaces. See product label for specific instructions for use.

## Micro-Kill One contact times\*

Contact time for a disinfectant is the amount of time a surface must remain wet with the product to achieve disinfection.

Micro-organism	Contact time
<i>Acinetobacter baumannii</i>	1 minute
<i>Burkholderia cepacia</i>	1 minute
<i>Campylobacter jejuni</i>	1 minute
Coronavirus, Human	1 minute
<i>Enterococcus faecalis</i> , Vancomycin-Resistant (VRE)	1 minute
<i>Escherichia coli</i> , O157:H7	1 minute
Hepatitis B Virus, (HBV)	1 minute
Hepatitis C Virus, (HCV)	1 minute
Herpes Simplex Virus, Type 1	1 minute
Human Immunodeficiency Virus, Type 1 (HIV-1) AIDS	1 minute
Influenza Virus Type A2	1 minute
<i>Klebsiella pneumoniae</i>	1 minute
<i>Listeria monocytogenes</i>	1 minute
Norovirus	1 minute
Poliovirus serotype 1	1 minute
<i>Pseudomonas aeruginosa</i>	1 minute
Respiratory Syncytial Virus (RSV)	1 minute
Rhinovirus	1 minute
Rotavirus Strain WA	1 minute
<i>Salmonella enterica</i>	1 minute
<i>Staphylococcus aureus</i>	1 minute
<i>Staphylococcus aureus</i> , Methicillin-Resistant (MRSA)	1 minute
<i>Streptococcus pyogenes</i> (Strep)	1 minute
<i>Trichopyton interdigitale</i> (formerly <i>T. mentagrophytes</i> ) (Athlete's Foot Fungus)	1 minute
Tuberculosis (TB) via <i>Mycobacterium bovis</i>	1 minute

EPA Reg. No. 88494-2-37549

\* Ensure that the hard, non-porous surface remains wet for the entire contact time.

† See Master Label EPA Reg. 88494-2 for complete list of micro-organisms and contact times.

# Medline Micro-Kill® Two Germicidal Wipes

Quat/Alcohol

**Quat/alcohol formula ideal for daily use**

**Kills *Candida auris* and 31 other micro-organisms in 2 minutes\* at the end of 2 minutes**

These germicidal wipes are a cleaner and disinfectant ideal for hospitals, surgical centers, ambulances, labs, long-term care facilities and other medical offices.

- Disinfects in 2 minutes
- For use on hard, non-porous surfaces
- Bactericidal, tuberculocidal, fungicidal and virucidal
- Quaternary/alcohol-based solution in a ready-to-use wipe
- Effective against SARS-CoV-2, *Candida auris* and TB



MSC351280

MSC351281

**KILLS  
32  
MICRO-ORGANISMS†**

## Ordering information\*\*

Item No.	Description	Pkg.
MSC351280	6" x 6.75" Wipes, 160-Count Canister	12/cs
MSC351281	7" x 15" Wipes, 75-Count Canister	12/cs



## Micro-Kill Two contact times\*

Contact time for a disinfectant is the amount of time a surface must remain wet with the product to achieve disinfection.

Micro-organism	Contact time
Acinetobacter baumannii	2 minutes
Adenovirus Type 5	2 minutes
Bordetella pertussis	2 minutes
Burkholderia cepacia	2 minutes
Campylobacter jejuni	2 minutes
Candida albicans	2 minutes
Candida auris	2 minutes
EBSL Producing <i>Escherichia coli</i> ( <i>E. coli</i> )	2 minutes
<i>Enterobacter cloacae</i> NDM-1 positive	2 minutes
<i>Escherichia coli</i> ( <i>E. coli</i> )	2 minutes
<i>Escherichia coli</i> O157:H7	2 minutes
Hepatitis B Virus (HBV)—Duck HB	2 minutes
Hepatitis C Virus (Human) (HCV)—Bovine Diarrhea Virus	2 minutes
Herpes Simplex Virus Type 2	2 minutes
HIV-1 (AIDS Virus)	2 minutes
Human Coronavirus	2 minutes
Influenza A Virus (H3N2)	2 minutes
Influenza A Virus (H1N1)	2 minutes
<i>Klebsiella pneumoniae</i>	1 minute
<i>Klebsiella pneumoniae</i> —KPC-2 positive, ST258 (multi-drug and carbapenem resistant)	2 minutes
Methicillin Resistant <i>Staphylococcus aureus</i> (MRSA)	2 minutes
<i>Mycobacterium bovis</i> -BCG (TB) (Tuberculosis)	1 minute
<i>Pseudomonas aeruginosa</i>	2 minutes
Respiratory Syncytial Virus (RSV)	2 minutes
Rhinovirus	2 minutes
Rotavirus	2 minutes
<i>Salmonella enterica</i>	2 minutes
Severe Acute Respiratory Syndrome-Related Coronavirus 2 (SARS-CoV-2) (COVID-19 Virus)	1 minute
<i>Staphylococcus aureus</i>	2 minutes
<i>Trichophyton interdigitale</i>	2 minutes
Vaccinia Virus	2 minutes
Vancomycin Resistant <i>Enterococcus faecalis</i> (VRE)	2 minutes

EPA Reg. No. 96706-1-37549

\* Ensure that the hard, non-porous surface remains wet for the entire contact time.

\*\* May not be available in all 50 states.

† See Master Label EPA Reg. No. 96706-1 for complete list of micro-organisms.

# Medline Micro-Kill® AF<sup>2</sup> Disinfectant Wipes

## Quat

Contact time of

**2**  
min.<sup>†</sup>

- 2-minute contact time\*
- Kills 45 micro-organisms on hard, non-food, non-porous surfaces
- Quat-based disinfectant

### Ordering information

Item No.	Description	Pkg.
MSC351000	6" x 6.75" Wipes, 160-Count Canister	12/cs
MSC351010	7" x 15" Wipes, 65-Count Canister	6/cs



MSC351000

MSC351010

### Micro-Kill AF<sup>2</sup> contact times\*

Contact time for a disinfectant is the amount of time a surface must remain wet with the product to achieve disinfection.



Micro-organism	Contact time	Micro-organism	Contact time
<i>Acinetobacter baumannii</i>	2 minutes	<i>Klebsiella pneumoniae</i>	2 minutes
<i>Acinetobacter baumannii</i> , Multi-Drug Resistant (MDR)	2 minutes	<i>Klebsiella pneumoniae</i> , Carbapenem Resistant	2 minutes
<i>Burkholderia cepacia</i>	2 minutes	<i>Klebsiella pneumoniae</i> , ESBL	2 minutes
<i>Campylobacter jejuni</i>	2 minutes	<i>Klebsiella pneumoniae</i> , NDM-1	2 minutes
<i>Candida albicans</i>	2 minutes	<i>Listeria monocytogenes</i>	2 minutes
Coronavirus, Human	2 minutes	<i>Proteus vulgaris</i>	2 minutes
Coronavirus, SARS Associated	2 minutes	<i>Pseudomonas aeruginosa</i>	2 minutes
<i>Enterococcus faecalis</i>	2 minutes	Respiratory Syncytial Virus (RSV)	2 minutes
<i>Enterococcus faecalis</i> , Vancomycin-Resistant (VRE)	2 minutes	Rotavirus	2 minutes
<i>Escherichia coli</i>	2 minutes	<i>Salmonella enterica</i>	2 minutes
<i>Escherichia coli</i> , O157:H7	2 minutes	<i>Salmonella enterica</i> , serovar Typhi	2 minutes
<i>Escherichia coli</i> , ESBL	2 minutes	SARS-Related Coronavirus 2 (SARS-CoV-2)	1 minute
<i>Escherichia coli</i> , NDM-1	2 minutes	<i>Shigella dysenteriae</i>	2 minutes
Hepatitis B Virus, (HBV)	2 minutes	<i>Staphylococcus aureus</i>	2 minutes
Hepatitis C Virus, (HCV)	2 minutes	<i>Staphylococcus aureus</i> , (CA-MRSA USA300)	2 minutes
Herpes Simplex Virus, Type 1	2 minutes	<i>Staphylococcus aureus</i> , (CA-MRSA USA400)	2 minutes
Herpes Simplex Virus, Type 2	2 minutes	<i>Staphylococcus aureus</i> , Multi-Drug Resistant to Tc, Pc, Em and Clindamycin	2 minutes
HIV-1 (AIDS Virus)	2 minutes	<i>Staphylococcus aureus</i> , Methicillin-Resistant (MRSA)	2 minutes
Influenza A, 2009 H1N1 (Novel H1N1)	2 minutes	<i>Staphylococcus aureus</i> , Vancomycin Intermediate-Resistant (VISA)	2 minutes
Influenza A Virus, (H3N2) Avian	2 minutes	<i>Staphylococcus aureus</i> , Vancomycin-Resistant (VRSA)	2 minutes
Influenza A Virus, (H5N1) Avian	2 minutes	<i>Streptococcus pneumoniae</i> , Penicillin-Resistant	2 minutes
Influenza A Virus, (H7N9) Human	2 minutes	<i>Streptococcus pyogenes</i> , associated with scarlet fever	2 minutes
Influenza A Virus H3N2	2 minutes	<i>Vibrio cholerae</i>	2 minutes
<i>Klebsiella aerogenes</i>	2 minutes		

\* Ensure that the hard, non-porous surface remains wet for the entire contact time.

† See Master Label EPA Reg. 6836-372 for complete list of micro-organisms.

EPA Reg. No. 6836-372-37549

# Medline Micro-Kill® D1 Plus Germicidal Wipes

## Dodecylbenzenesulfonic Acid (DDBSA) Solution

**DDBSA formula kills TB in 45 seconds and bacteria and viruses in 1 minute\***

**One-step\*\* multi-purpose cleaner and disinfectant effective on hard, non-porous surfaces**

- Gentle on surfaces
- Bactericidal, tuberculocidal, fungicidal and virucidal

### Ordering information\*\*\*

Item No.	Description	Pkg.
MSC351700	6" x 6.75" Wipes, 220-Count Canister	12/cs
MSC351710	11" x 12" Wipes, 70-Count Canister	12/cs

### Micro-Kill contact times

Contact time for a disinfectant is the amount of time a surface must remain wet with the product to achieve disinfection.

Micro-organism	Contact time
<i>Acinetobacter baumannii</i> (MDR)	1 minute
Adenovirus Type 5 strain Adenoid 75	1 minute
Avian Influenza A strain VN5N1-PR8/CDC-RG ‡	1 minute
<i>Bordetella pertussis</i>	1 minute
Bovine Viral Diarrhea virus ‡	1 minute
<i>Candida albicans</i>	1 minute
<i>Candida auris</i>	75 seconds
Canine Parvovirus Strain Cornell-780916-80 ‡	1 minute
Cytomegalovirus Strain AD-169	1 minute
Duck Hepatitis B virus ‡	1 minute
<i>Enterococcus faecalis</i> Vancomycin-resistant Enterococci (VRE)	1 minute
<i>Enterococcus faecium</i> Multi-drug resistant (MDR)	1 minute
<i>Escherichia coli</i>	1 minute
<i>Escherichia coli</i> O157:H7	1 minute
<i>Escherichia coli</i> —Extended-Spectrum Beta-Lactamase (ESBL) producing	1 minute
<i>Escherichia coli</i> —New Delhi metallo-beta-lactamase 1 (NDM-1) producing	1 minute
Feline Calicivirus strain F-9 (ATCC VR-782) ‡	1 minute
Hepatitis B Virus HBV (Duck Hepatitis B as the surrogate)	1 minute
Hepatitis C Virus HCV (Bovine Viral Diarrhea virus as the surrogate)	1 minute
Herpes simplex virus type 1, Strain F(1)	1 minute
Herpes simplex virus type 2, Strain G	1 minute
Human Coronavirus strain 229E	1 minute
Human Immunodeficiency Virus type 1 (HIV-1) Strain HTLV-III <sub>B</sub>	1 minute
Human Rotavirus Strain WA	1 minute

### Common uses

Medical, dental and laboratory countertops, telephones, sink tops, toilet seats, glazed porcelain, stainless steel, Formica®, vinyl and most plastic surfaces.



MSC351700

MSC351710



Overall contact time of

**1 min.†**

Micro-organism	Contact time
Human Rhinovirus Type 37 strain 151-1	1 minute
Influenza A virus	1 minute
Influenza B virus Strain B/Lee/40	1 minute
<i>Klebsiella pneumoniae</i> Carbapenemase producer (KPC)	1 minute
<i>Klebsiella pneumoniae</i> Multi-drug resistant (MDR)	1 minute
<i>Klebsiella pneumoniae</i> New Delhi metallo-beta-lactamase 1 (NDM-1) producing	1 minute
<i>Mycobacterium bovis</i> (BCG) (TB)	45 seconds
Norovirus Feline Calicivirus FCV, strain F-9 as the surrogate	1 minute
<i>Proteus mirabilis</i> Extended-Spectrum Beta-Lactamase (ESBL) producing	1 minute
<i>Pseudomonas aeruginosa</i>	1 minute
Respiratory syncytial virus (RSV) Strain Long	1 minute
<i>Salmonella enterica</i> subspecies <i>enterica</i> serovar Typhi	1 minute
<i>Staphylococcus aureus</i>	1 minute
<i>Staphylococcus aureus</i> CA-MRSA Genotype USA 400	1 minute
<i>Staphylococcus aureus</i> Methicillin Resistant (MRSA)	1 minute
<i>Staphylococcus aureus</i> VISA	1 minute
<i>Stenotrophomonas maltophilia</i>	1 minute
<i>Streptococcus pyogenes</i>	1 minute
<i>Trichophyton interdigitale</i>	75 seconds
Vaccinia virus, Strain WR	1 minute
<i>Vibrio cholerae</i>	1 minute

EPA Reg. No. 1677-263-37549

\* Ensure that the hard, non-porous surface remains wet for the entire contact time.

\*\* Pre-clean step required for \*HIV-1, \*HBV, \*HCV and *C. auris*.

\*\*\* May not be available in all 50 states.

† See Master Label EPA Reg. No. 1677-263 for complete list of micro-organisms.

‡ Animal pathogen.

# WipesPlus® No-Rinse Food Contact Multi-Surface Wipes

No-rinse

## Formulated to aid in the reduction of cross-contamination in all food service environments

- Cleans, disinfects and deodorizes in one labor saving step<sup>^</sup>
- EPA registered, on EPA's List N and NSF registered\*\*\*
- Kills foodborne pathogens such as Norovirus, *Salmonella enterica*, *Listeria monocytogenes* and *E. coli*
- Effective against SARS-CoV-2 in 1 minute
- Safe to use on most hard, non-porous surfaces, including food contact surfaces, with no rinse required

### Ordering information\*\*

Item No.	Description	Pkg.
EVSPGP33808	7" x 9" Wipes, 100-Count Canister	12/cs



EVSPGP33808

Contact time of

**5**  
min.<sup>†</sup>

### Common uses

Wipes are intended for use on hard, non-porous surfaces including food contact surfaces. Spot test on inconspicuous area before use. See label for specific instructions for use.

### WipesPlus disinfection contact times\*

Contact time for a disinfectant is the amount of time a surface must remain wet with the product to achieve disinfection.

Micro-organism	Contact time
<i>Escherichia coli</i> ( <i>E. coli</i> )	5 minutes
<i>Escherichia coli</i> O157:H7	5 minutes
HIV-1	5 minutes
Human Coronavirus	5 minutes
Human Norovirus	5 minutes
Influenza A Virus	5 minutes
<i>Klebsiella pneumoniae</i>	5 minutes
<i>Listeria monocytogenes</i>	5 minutes
Measles Virus	1 minute
<i>Pseudomonas aeruginosa</i>	5 minutes
Respiratory Syncytial Virus	5 minutes
<i>Salmonella enterica</i>	5 minutes
<i>Salmonella typhi</i>	5 minutes
SARS-Related Coronavirus 2 (SARS-CoV-2)	1 minute
<i>Shigella dysenteriae</i>	5 minutes
<i>Staphylococcus aureus</i>	5 minutes
<i>Staphylococcus aureus</i> , Community Associated Methicillin-Resistant	5 minutes
<i>Staphylococcus aureus</i> , Methicillin-Resistant	5 minutes
<i>Yersinia enterocolitica</i>	5 minutes

### WipesPlus sanitizing times\*

Micro-organism	Contact time
<i>Escherichia coli</i>	30 seconds
<i>Klebsiella pneumoniae</i>	30 seconds
<i>Listeria monocytogenes</i>	30 seconds
<i>Salmonella enterica</i>	30 seconds
<i>Staphylococcus aureus</i>	30 seconds

EPA Reg. No. 6836-379-75399

<sup>^</sup> When used according to the directions for disinfection.

<sup>\*</sup> Ensure that the hard, non-porous surface remains wet for the entire contact time.

<sup>\*\*</sup> May not be available in all 50 states.

<sup>\*\*\*</sup> NSF 158388

<sup>†</sup> See Master Label EPA Reg. 6836-379 for complete list of micro-organisms.

**KILLS**  
**19**  
MICRO-ORGANISMS<sup>†</sup>

# Canister Holder

## Standard Canister Holder

- Holds most canister sizes for ease and quick accessibility of wipes
- Wall mountable; mounting hardware included
- Also compatible with hand hygiene

Item No.	Description	Pkg.
MSC351128	Standard Wall Mount Canister Bracket	12/cs



MSC351128

# Surface Cleaners

## Touch Screen Cleaning Wipe\*

- Designed to clean touch screens and energized equipment recommending 70% isopropyl alcohol
- Cleans dirt, grime, fingerprints and smudges
- For cleaning purposes only; this is not a disinfectant or sterilant

Item No.	Description	Pkg.
MSC351500A	6" x 6" Touch Screen Cleaning Wipes, 160-Count Canister	12/cs

\*This item is a cleaning product and is not intended for disinfection.



Great for digital tech

MSC351500A

## Stainless Steel Cleaning Wipe

- Citrus-based formula removes hard-water stains, grease smudges, oily fingerprints and food spills from virtually any stainless steel surface or appliance
- As the wipes clean they brighten, polish and protect surfaces, leaving a clear coating that acts as a protective shield
- The dual-purpose towels have one abrasive, nonscratching side to scrub surfaces, and a smooth side to wipe the surface clean

Item No.	Description	Pkg.
CHU5505	Champion Stainless Steel Wipes, 9.5" x 12", 40 ct	6/cs



CHU5505

CLEANING CHEMICAL SYSTEMS

# Nine ways that Medline cleaning chemicals help you improve efficiency

1. Improved safety with the right dilution
2. Less waste from using only the chemicals you need
3. A time-saving bottle fill
4. Virtually maintenance-free
5. Easy training and product selection
6. Easy operation
7. SKU consolidation
8. Streamlined chemical purchasing
9. Strong, effective cleaning products

**Metering tips**

Leakproof valves help reduce spills. Metering tip is in the bottle, delivering the right dilution, every time.

**Multilingual labeling**  
English, Spanish and French.



**Intuitive Icons**  
Provides at-a-glance identification for area of use.

**Product Color-Coding**  
Makes training and product selection easier.

# DISPENSED CHEMICALS

## Disinfectants

### Micro-Kill Q3 Concentrated Disinfectant, Cleaner and Deodorizer

- Concentrated disinfectant, cleaner and deodorizer with 51 efficacy claims
- 3-minute contact time for *Staphylococcus aureus*, *E. coli* and *Candida albicans*
- One-step spot sanitizer for soft surfaces
- EPA-registered disinfectant, cleaner and deodorizer for hard, non-porous, non-food contact surfaces
- For Medline chemical dispensing systems; tested and validated for use in electrostatic sprayers

EPA Reg. No. 6836-349-37549

Item No.	Description	Pkg.
EVSCHM110	Micro-Kill Q3 Disinfectant, 0.5 gal	4/cs
EVSCHM005	Preprinted Empty "Micro-Kill Q3" Spray Bottle, 32 oz	6/cs

**Dispensed Chemicals:** Concentrated chemicals designed for use in any dispenser in this section. All dispensed chemicals include four 64-oz containers per case.



EVSCHM110



EVSCHM005

### Medline Micro-Kill NQ5\* Disinfectant

- One-step disinfectant\*\*
- 5-minute contact time; tested and validated for use in Electrostatic Sprayers\*\*
- EPA-registered disinfectant, cleaner and deodorizer for hard non-porous surfaces
- Leaves a fresh clean scent
- For Medline chemical dispensing systems

EPA Reg. No. 6836-364-37549

Item No.	Description	Pkg.
EVSCHM215	Micro-Kill NQ5 Disinfectant, 0.5 gal	4/cs
EVSCHM007	Preprinted Empty "Micro-Kill NQ5" Spray Bottle, 32 oz	6/cs

\*May not be available in all states.

\*\*On hard, non-porous, non-food surfaces



EVSCHM007



EVSCHM215

### Micro-Kill Q10 All-In-One Cleaner

- One step multi-purpose cleaner for hard, non-porous surfaces including glass and floors
- EPA-registered disinfectant, cleaner for hard non-porous surfaces
- For Medline chemical dispensing systems
- 10-minute contact time

EPA Reg. No. 106-73-37549

Item No.	Description	Pkg.
EVSCHM100A	Micro-Kill Q10 disinfectant, 0.5 gal	4/cs
EVSCHM008	Preprinted Empty "Micro-Kill Q10" Spray Bottle, 32 oz	6/cs



EVSCHM100A



EVSCHM008

## DISPENSED CHEMICALS

## Floor Care

**Neutral Floor Cleaner**

- For daily cleaning and damp dusting
- Neutral pH won't dull floors
- Citrus fragrance
- For Medline chemical dispensing systems (1:512 dilution)
- Yields 1,024 gallons of diluted product per case

Item No.	Description	Pkg.
EVSCHM210	Neutral Floor Cleaner, 0.5 gal	4/cs
EVSCHM009	Preprinted Empty "Neutral Floor Cleaner" Spray Bottle, 32 oz	6/cs



EVSCHM210

**General Purpose Cleaner**

- For removing heavy soils and performing scrub-and-recoat procedures
- High-alkaline, heavy-duty cleaner and floor degreaser
- Citrus fragrance
- For Medline chemical dispensing systems (1:256 dilution)
- Yields 512 gallons of diluted product per case

Item No.	Description	Pkg.
EVSCHM220	General Purpose Cleaner, 0.5 gal	4/cs



EVSCHM220

**Floor Rejuvenator**

- Extends strip cycle, fills in light scratches and removes embedded soil
- Restorer that makes floors shine like new
- Fragrance-free
- For Medline chemical dispensing systems (1:128 dilution)
- Yields 256 gallons of diluted product per case

Item No.	Description	Pkg.
EVSCHM580	Floor Restorer/Maintainer, 0.5 gal	4/cs



EVSCHM580

**Multi-Surface Lavender Cleaner**

- Multi-purpose cleaner to deodorize and remove soil from surfaces
- Lavender fragrance
- For Medline chemical dispensing systems (1:64 dilution)
- Yields 128 gallons of diluted product per case

Item No.	Description	Pkg.
EVSCHM212	Multi-Surface Lavender Cleaner, 0.5 gal	4/cs
EVSCHM006	Preprinted Empty Multi-Surface Lavender Spray Bottle, 32 oz	6/cs



EVSCHM212

# DISPENSED CHEMICALS

## Surface Cleaners

### Glass/Multi-Surface Cleaner

- Streak-free on glass and reflective surfaces, and can be used to clean stainless steel
- Non-ammoniated for lower odor
- Fresh, clean fragrance
- For Medline chemical dispensing systems (1:32 dilution)
- Yields 86 gallons of diluted product per case

Item No.	Description	Pkg.
EVSCHM200A	Multi-Surface Glass Cleaner, 0.5 gal	4/cs
EVSCHM003	Preprinted Empty "Glass Cleaner" Spray Bottle, 32 oz	6/cs



EVSCHM200



EVSCHM003

### Multi-Surface Peroxide Cleaner

- True all-in-one surface cleaner
- Hydrogen-peroxide based solution for heavy-duty soils on glass, surfaces, floors and carpets
- Floral fragrance
- For Medline chemical dispensing systems (1:256 dilution)
- Yields 512 gallons of diluted product per case

Item No.	Description	Pkg.
EVSCHM230	Multi-Surface Peroxide Cleaner, 0.5 gal	4/cs
EVSCHM001	Preprinted Empty "Multi-Surface Peroxide" Spray Bottle, 32 oz	6/cs



EVSCHM230



EVSCHM001

### Odor Counteractant

- Reducing odors can help patient satisfaction
- Non-staining, can be sprayed in air, on surfaces, and on fabrics
- Citrus/floral blend fragrance
- For Medline chemical dispensing systems (1:64 dilution)
- Yields 128 gallons of diluted product per case

Item No.	Description	Pkg.
EVSCHM300	Odor Counteractant, 0.5 gal	4/cs
EVSCHM002	Preprinted "Odor Control" Spray Bottle, 32 oz	6/cs



EVSCHM300



EVSCHM002

# Medline Chemical Dispensers

## Four-Chamber Chemical Dispenser

- Lockable cabinet for dispensing chemicals from half-gallon containers
- Two-button design makes filling bottles and buckets easy
- Metering tips built into the chemicals, not the dispenser, minimizing maintenance and breakdowns
- Bucket hose storage
- Easy installation

Item No.	Description	Pkg.
EVSCHMDISP04	Four-Chamber Wall-Mounted Chemical Dispenser	1 ea



EVSCHMDISP04

## Two-Chamber Chemical Dispenser

- Wall-mounted dispenser for dispensing chemicals from half-gallon containers
- Two-button design makes filling bottles and buckets easy
- Metering tips built into the chemicals, not the dispenser, minimizing maintenance and breakdowns
- Easy installation

Item No.	Description	Pkg.
EVSCHMDISP02	Two-Chamber Wall-Mounted Chemical Dispenser	1 ea



EVSCHMDISP02

## Handheld Chemical Dispenser

- Fill machines with chemicals in situations that don't allow for easy access inside the water closet

Item No.	Description	Pkg.
EVSCHMDISP01	Handheld Chemical Dispenser	1 ea



EVSCHMDISP01

## Accessories

- For mixing and dispensing concentrated cleaning products
- Graduated for convenient measuring

Item No.	Description	Pkg.
EVS4900H	Trigger Sprayer	1 ea
EVSCHEM010	Flip-Top Cap	1 ea
EVS4932H	Plastic Bottle, 32 oz	1 ea



EVS4900H

EVSCHEM010

EVS4932H

Ask your Medline Representative about how to get your Chemical Dispensers at no charge.

# NON-DISPENSED CHEMICALS

## Disinfectants

**Non-Dispensed Chemicals:** Provide your staff with convenience and efficiency when a water closet isn't available

### Medline Micro-Kill R2\*

- Low, 2-minute contact time—see product label for specific list of micro-organisms
- EPA-registered disinfectant, soft surface sanitizer, cleaner and deodorizer for hard, non-porous surfaces

EPA Reg. No. 1839-220-37549

Item No.	Description	Pkg.
EVSCHEM122	Medline Micro-Kill R2, 32-oz Bottle	12/cs

\*May not be available in all states.



EVSCHEM122

### Husky 814 Q/T Tuberculocidal Spray Disinfectant

- Cleaner, deodorizer and mildewstat
- Effective tuberculocidal disinfectant on hard, nonporous surfaces
- Contact time from 30 seconds to 10 minutes—see product label for specific list of micro-organisms and contact times

EPA Reg. number: 1839-83-8155

Item No.	Description	Pkg.
CADEVS81403	Husky 814 Q / T Tuberculocidal Spray Disinfectant, 32 oz	12/cs



CADEVS81403

### Pure Hard Surface Disinfectants

- Patented molecule, silver dihydrogen citrate (SDC), is rated in the lowest toxicity category, IV
- 5-minute contact time—see product label for specific list of micro-organisms
- Safe to use on food contact surfaces without rinsing
- Child Safety Network 2011 Safe Family Seal of Approval
- EPA-registered disinfectant and deodorizer for hard non-porous surfaces

EPA Reg. No. 72977-5-63679

Item No.	Description	Pkg.
CBL4000111	32-oz, 2 Trigger Sprayers	12/cs
CBL4215014	1 gal	2/cs
CBL4215035	2.5 gal	1 ea



CBL4215014

CBL4000111

### Medline Micro-Kill Foaming Disinfectant Cleaner

- Aerosol spray for easy cleaning
- 10-minute contact time
- Non-abrasive quat-based formula—no scrubbing or rinsing necessary
- EPA-registered disinfectant, cleaner and deodorizer for hard non-porous surfaces

EPA Reg. No. 498-62-37549

Item No.	Description	Pkg.
EVSCHEM711	17-oz Medline Micro-Kill Foaming Disinfectant Cleaner	12/cs



EVSCHEM711

NON-DISPENSED CHEMICALS

# Sporicidal Disinfectants

## Micro-Kill Bleach Germicidal Bleach Solution

EPA-registered product kills *Clostridium difficile* spores<sup>1</sup> in 5 minutes.\*\*

### Common uses

Micro-Kill Bleach Germicidal Bleach Solution is an effective method to clean, deodorize and disinfect hard, non-porous environmental and healthcare surfaces. See product label for specific instructions for use.

### Ordering information\*\*

Item No.	Description	Pkg.
EVSCHM900	Liquid Bleach, 1 gal	4/cs
EVSCHM910	Liquid Bleach, 32 oz	12/cs

Bleach Solution equivalent to 1:10 dilution of 6.5% bleach.

Overall contact time of

**5** min.†



EVSCHM900

EVSCHM910

1. Environmental Protection Agency List K: Antimicrobial Products Registered with EPA for Claims Against *Clostridium difficile* Spores October 4, 2023.

### Micro-Kill Bleach Germicidal Bleach Solution contact times\*

Contact time for a disinfectant is the amount of time a surface must remain wet with the product to achieve disinfection.

Micro-organism	Kill time
<i>Acinetobacter baumannii</i> -MDR	30 seconds
Adenovirus Type 5	30 seconds
Avian Influenza A Virus (H3N2)	30 seconds
Avian Influenza A Virus (H5N1)	30 seconds
Avian Influenza A Virus (H7N9)	30 seconds
<i>Bordetella pertussis</i>	30 seconds
CA-Methicillin Resistant <i>Staphylococcus aureus</i>	30 seconds
<i>Candida albicans</i>	1 min
<i>Campylobacter jejuni</i>	30 seconds
Canine Parvovirus	30 seconds
<i>Clostridium difficile</i> spores	5 min
Cytomegalovirus (Strain AD-169)	30 seconds
<i>Enterobacter aerogenes</i>	30 seconds
<i>Enterobacter cloacae</i>	30 seconds
<i>Enterococcus faecalis</i> -VRE	30 seconds
<i>Enterococcus faecium</i> -MDR	30 seconds
Enterovirus Type D68	30 seconds
<i>Escherichia coli</i>	30 seconds
<i>Escherichia coli</i> O157:H7	30 seconds
<i>Escherichia coli</i> -ESBL	30 seconds
<i>Escherichia coli</i> -NDM-1	30 seconds
Feline Panleukopenia Virus (Feline Parvovirus)	30 seconds
Hepatitis A Virus	30 seconds
Hepatitis B Virus	30 seconds
Hepatitis C Virus	30 seconds
Herpes Simplex Virus Type 2	30 seconds
Human Coronavirus	30 seconds
Human Immunodeficiency Virus Type 1	30 seconds
Influenza A Virus	30 seconds
Influenza A Virus (H1N1)	30 seconds

Micro-organism	Kill time
Influenza B Virus (Strain B)	30 seconds
<i>Klebsiella pneumoniae</i>	30 seconds
<i>Klebsiella pneumoniae</i> -CRKP (CRE)	30 seconds
<i>Klebsiella pneumoniae</i> -ESBL	30 seconds
<i>Klebsiella pneumoniae</i> -NDM-1	30 seconds
<i>Legionella pneumophila</i>	30 seconds
Linezolid Resistant <i>Staphylococcus aureus</i>	30 seconds
<i>Listeria monocytogenes</i>	30 seconds
Methicillin Resistant <i>Staphylococcus aureus</i> (MRSA)	30 seconds
<i>Neisseria gonorrhoeae</i>	30 seconds
Norovirus (Feline Calicivirus) (Norwalk Virus)	30 seconds
Poliovirus (Type 1)	30 seconds
<i>Proteus mirabilis</i>	30 seconds
<i>Pseudomonas aeruginosa</i>	30 seconds
Respiratory Syncytial Virus	30 seconds
Rhinovirus (Type 37)	30 seconds
Rotavirus	30 seconds
<i>Salmonella enterica</i>	30 seconds
SARS-Related Coronavirus 2 (SARS-CoV-2)	30 seconds
<i>Serratia marcescens</i>	30 seconds
<i>Shigella dysenteriae</i>	30 seconds
<i>Staphylococcus aureus</i>	30 seconds
<i>Staphylococcus aureus</i> -VISA	30 seconds
<i>Staphylococcus aureus</i> -VRSA	30 seconds
<i>Streptococcus pneumoniae</i>	30 seconds
<i>Streptococcus pyogenes</i>	30 seconds
<i>Trichophyton interdigitale</i>	1 min
Vaccinia Virus	30 seconds

EPA Reg. No. 37549-2

\* Ensure that the hard, non-porous surface remains wet for the entire contact time.

\*\* May not be available in all 50 states.

† See Master Label EPA Reg. 37549-2 for complete list of micro-organisms.

‡ Follow the Special Instructions for Cleaning prior to Disinfection for *Clostridium difficile* spores.

## NON-DISPENSED CHEMICALS

## Additional Disinfectants

**Pure Bright Germicidal Ultra Bleach**

- Concentrated bleach with 6% sodium hypochlorite
- Large handle with offset opening for ergonomic pour
- Vented induction seal prevents spillage
- This product has demonstrated effectiveness against viruses similar to Mpox virus on hard, nonporous surfaces and therefore can be used against Mpox virus when used in accordance with the directions for use against Feline Calicivirus (Norovirus) on hard, nonporous surfaces

EPA Reg. No. 70271-13

Item No.	Description	Pkg.
LGSKIKBLEACH6	Pure Bright Germicidal Ultra Bleach Liquid Concentrate, 1 gal	6/cs



LGSKIKBLEACH6

**Pure Bright Ready-to-Use Germicide with Bleach**

- 2% sodium hypochlorite spray
- EPA-registered disinfectant effective against SARS-Related Coronavirus (SARS-CoV-2)
- Bactericidal/virucidal/germicidal/mildewcidal

EPA Reg. No. 70271-15

Item No.	Description	Pkg.
LGSKIKRTU	Pure Bright Ready-to-Use Germicide with Bleach, 32 oz	9/cs



LGSKIKRTU

**BruTab 6S**

- Effective against *Clostridioides difficile* spore and Norovirus
- Chlorine donor based technology
- Tested and validated for use in electrostatic sprayers

EPA Reg. No. 71847-6-106

Item No.	Description	Pkg.
BRI1610218G	BruTab6S Disinfectant Tablet, 3.34 g, 200 Tablets/Tub	6 tubs/cs
BRI001	BruTab6S Wide-Neck Trigger Spray Bottle, 24 oz	6/cs
BRI002	BruTab6S Wide-Neck Pour Top Bottle, 32 oz, 1 Trigger Spray Included	6/cs
BRI002L	BruTab6S Label	10/cs
BRI002T	Trigger Spray Head for Wide-Neck Bottle	1 ea
BRI003	BruTab6S Disinfectant Tablet Transport Pack	10/cs



BRI1612018N



BRI001

## NON-DISPENSED CHEMICALS

# Floor Care

### Multi-Speed Floor Finish

- Premium blend of 22% solids provides great durability and shine, regardless of maintenance program used
- Shows excellent resistance to alcohol-based sanitizers
- Multi-speed—can be used with low/high speed machines
- Multi-surface—can be used on VCT and stone

Item No.	Description	Pkg.
EVSCH510	Multi-Speed Floor Finish, 2.5 gal	2/cs



EVSCH510

### DuraPro 25™ Floor Finish

- Fast shine and superb gloss with 25% solids
- Consistent spreading and easy leveling
- Excellent mark and scuff resistance to stand up to heavy traffic
- The durability to extend your scrub, recoat and strip cycle
- 2,000–2,500 square feet of floor coverage per gallon

Item No.	Description	Pkg.
EVSCH520	High-Gloss Floor Finish, 2.5 gal	2/cs



EVSCH520

### Heavy-Duty Floor Stripper

- Strong formula removes finish down to bare floors
- 1:32 dilution

Item No.	Description	Pkg.
EVSCH550	Heavy-Duty Floor Stripper, 32 oz	6/cs



EVSCH550

### Low-Odor Floor Stripper

- For areas with high traffic or patient/resident rooms; dilute to a 1:32 ratio

Item No.	Description	Pkg.
EVSCH560	Low-Odor Floor Stripper, 32 oz	6/cs



EVSCH560

### Baseboard Stripper

- Protect your baseboards by using an aerosol instead of a traditional floor stripper

Item No.	Description	Pkg.
EVSCH750	Baseboard Stripper, 19 oz	12/cs



EVSCH750

## NON-DISPENSED CHEMICALS

## Floor Care

**Ultra Shine Floor Finish Restorer**

- Reduce mop and machine drag and enhance burnishing results
- Innovative pour spout ensures proper dilution

Item No.	Description	Pkg.
EVSCHM590	Ultra Shine Floor Finish Restorer, 32 oz	4/cs



EVSCHM590

**UltraShield Floor Protection Burnishing Formula**

- Slip-resistant and super high-gloss
- Extends floor life
- Apply via spray bottle or mop

Item No.	Description	Pkg.
ULSUSBRN002L	UltraShield Floor Protection Burnishing Formula, 1 L	2/cs
ULSUSBRN006L	UltraShield Floor Protection Burnishing Formula, 1 L	6/cs



ULSUSBRN002L

**Tuff-Shine One-Step Clean and Polish Solution**

- Cleans and shines with no rinsing
- Use on a regular basis for added protection
- Applied through mop or auto floor scrubber
- Polishes to a high gloss
- Great for commercial sheet flooring, sheet vinyl, rubber, linoleum, PVC, LVT, stone, etc

Item No.	Description	Pkg.
ULSUSTUF25G	Tuff Shine Cleaner, 2.5 gal.	1 ea



ULSUSTUF25G

**ArmorGuard Floor Protector Finish**

- Easy-to-maintain floor coating is stain, scuff and scratch resistant
- Nano-particulate xpolymer technology produces an exceptionally resilient floor
- Dirt-, water- and stain-resistant finish makes for easy dusting and wet mopping
- Reduces need to scrub, recoat or strip floors

Item No.	Description	Pkg.
ULSUS10905G	ArmorGuard Floor Protector Finish, 2.5 gal	2/cs



ULSUS10905G

**Barbicide Disinfectants**

- For immersion of barber/salon instruments
- Safe for nonporous surfaces including tanning beds, combs, brushes and shears

EPA Reg. No. 954-11

Item No.	Description	Pkg.
PKTEVS20060	Barbicide EPA Registered Disinfectant	6/cs
PKTEVS52410	Barbicide Disinfecting Jar, 21 oz.	12/cs
PKTEVS51650	Barbicide TB, 16 oz.	12/cs
PKTEVS54210	Barbicide Disinfecting Jar, 37 oz.	12/cs



PKTEVS20060

# NON-DISPENSED CHEMICALS

## Bathroom Cleaners

### Heavy-Duty Toilet Bowl Cleaner

- For heavy rust and scale buildup
- Contains hydrochloric acid to remove rust and scale from toilet bowls
- Floral fragrance

Item No.	Description	Pkg.
EVSCHM440	9.5% Heavy-Duty Toilet Bowl Cleaner, 32 oz	12/cs



EVSCHM440

### Non-Acid Bowl Cleaner

- Budget friendly, for daily-use
- Blue color so you know the toilet is clean
- Fresh fragrance

Item No.	Description	Pkg.
EVSCHM430	Non-Acid Toilet Bowl Cleaner, 32 oz	12/cs



EVSCHM430

### Crème Cleanser

- For removal of heavy buildup of soap scum, scale and rust
- Mildly-abrasive thickened cleanser
- Sassafras fragrance

Item No.	Description	Pkg.
EVSCHM410	Mild Abrasive Crème Cleanser, 40 oz	12/cs



EVSCHM410

### Foaming Acid Cleaner

- Dissolves tough rust, scale and soap scum
- Foaming acidic shower cleaner
- Lime fragrance

Item No.	Description	Pkg.
EVSCHM450	Foaming Acid Shower Cleaner, 32 oz	12/cs



EVSCHM450

### Drain Opener

- Thickened formula sinks and clings to point of obstruction
- Highly effective against fats, oils, lint and hair
- Odorless and non-flammable

Item No.	Description	Pkg.
EVSCHM470	Drain Opener, 32 oz	12/cs



EVSCHM470

## NON-DISPENSED CHEMICALS

## Cleaners

**Free and Clear Laundry Detergent with Built-In Fabric Softener**

- Detergent is free of formaldehyde and dyes
- Biodegradable, greywater and septic safe, pH balanced
- Protects colors and fabrics
- Uses one ounce per high-efficiency (HE) load and two ounces for standard loads

Item No.	Description	Pkg.
EVSCHEM820	Free and Clear, 1 gal	4/cs



EVSCHEM820

**Medline Dish Soap**

- Dishwashing concentrate with aloe vera
- Quickly cuts through grease, baked on food, and stains
- High soil load capacity
- For manual washing of utensils, flatware, glasses, pots, and pans

Item No.	Description	Pkg.
EVSDISH440	Blue Dish Soap, Lemon, 38 oz	8/cs



EVSDISH440

**Ammoniated Glass Cleaner**

- Streak-free cleaner for glass, mirrors and other hard surfaces
- Dries quickly
- Ready to use

Item No.	Description	Pkg.
EVSCHEM201	Glass and Utility Cleaner, 32 oz	12/cs



EVSCHEM201

**Tile and Grout Cleaner**

- Highly effective at removing mold and mildew stains
- Leaves surfaces clean and smelling fresh
- Gentler than using bleach

Item No.	Description	Pkg.
EVSCHEM600	Tile and Grout Cleaner, 32 oz	12/cs



EVSCHEM600

## NON-DISPENSED CHEMICALS

# Cleaners

### Polishes

- Use on both wood and stainless steel for SKU consolidation
- Clean, polish and protect
- Lemon fragrance

Item No.	Description	Pkg.
EVSCHM400	Multi-Purpose Cream Polish, 32 oz	12/cs
EVSCHM740	Multi-Surface Polish, Aerosol, 20 oz	12/cs



EVSCHM400 EVSCHM740

### Heavy-Duty Degreaser

- Removes graffiti, oils, and sticky residues with ease
- Non-butyl, heavy solvent-based degreaser
- Floral fragrance

Item No.	Description	Pkg.
EVSCHM460	Heavy-Duty Degreaser, 32 oz	12/cs



EVSCHM460

EVSCHM610

### Carpet Spotter

- Versatile, multi-stain spotter brings out carpet colors
- Removes general stains, organic soils, and even red juice
- Hydrogen-peroxide based
- Floral fragrance

Item No.	Description	Pkg.
EVSCHM610A	General Purpose Carpet Spotter, 32 oz	12/cs

### Digester/Eliminator

- Effective hard surface cleaner and odor counteractant
- Enzymatic to eliminate odors
- Removes odors from organic soils such as urine and uric acid
- Lavender fragrance

Item No.	Description	Pkg.
EVSCHM480	Uric Eradicator, 32 oz	12/cs



EVSCHM480

# Victory Sprayers

Convenient, effective professional dispensers for disinfecting, sanitizing, odor removal, decontamination, pesticides/fertilizing, and more

## Cordless Electrostatic Handheld Sprayer

- Ergonomic chemical dispenser with a 1-liter, easy-fill tank
- 3-in-1 nozzle adjusts for coverage and run time per tank
- Up to four hours run time; handle lock for safety and comfort
- LED headlight for visibility; durable glass-filled housing
- 3.8 lb empty; 5.9 lb full



EVSSPRAYHH

Item No.	Description	Pkg.
EVSSPRAYHH	Victory Handheld Sprayer	1 ea
EVSSPRAYBAT	Victory Sprayer Rechargeable Battery	1 ea

## Cordless Electrostatic Backpack Sprayer

- Wearable chemical dispenser with a 2.25-gal easy fill tank
- 3-in-1 nozzle adjusts for coverage and run time per tank
- Up to four hours run time; handle lock for safety and comfort
- LED headlight for visibility; durable glass-filled housing
- 10 lb empty; 28.8 lb full



EVSSPRAYBP

Item No.	Description	Pkg.
EVSSPRAYBP	Victory Backpack Sprayer	1 ea
EVSSPRAYBAT	Victory Sprayer Rechargeable Battery	1 ea

## Products that are tested and validated for use in the Victory Sprayer

Item No.	Description	Pkg.
EVSCHEM110	Micro-Kill Q3 Disinfectant, 0.5 gal	4/cs
EVSCHEM122	Medline Micro-Kill R2, 32 oz Bottles	12/cs
EVSCHEM215	Micro-Kill NQ5 Disinfectant, 0.5 gal	4/cs
BRI1610218G	BruTab6S Disinfectant Tablets, 3.34 g, 200 Tablets/Tub	6 tubs/cs

EVSCHEM110

EVSCHEM215



EVSCHEM122

BRI1610218G

# Sprayers

## FlexSpray Sprayer

- Engineered for smaller surfaces and objects
- Great speed and portability for smaller jobs
- Flow speed can be adjusted for greater control
- Max flow of 0.20 gpm

Item No.	Description	Pkg.
NIL524093	Handheld Sprayer	1 ea



NIL524093

## Impact 410 Sprayer

- Airless sprayers provide high application speed
- Assists with regular application of cleaning and disinfectant solutions

Item No.	Description	Pkg.
NIL56394501	Impact 410 Skid with Two HEA 413 Tips	1 ea
NIL56394504	Impact 410 Transport Wheels and Bucket Holder	1 ea



NIL56394501

## Impact 440 HR Sprayer

- Sprayers with highly efficient airless spray technology help deliver optimal wetting with a large fan pattern with bigger droplets
- Great for medium-size surfaces
- Configure pressure from 500 to 1,200 PSI, 0.47 to 0.70 gpm

Item No.	Description	Pkg.
NIL56394508	Impact 440 HR Impact Sprayer with 2 HEA 413 Tips	1 ea



NIL56394508

## Air Mister

- Versatile spraying unit
- 15-gal tank to provide continual usage

Item No.	Description	Pkg.
PAC685401	Air Mister	1 ea



PAC685401

# Spectra 1000 UV Light Disinfection System\*

## Integrated surface and air room disinfection device

Spectra 1000 provides an additional line of defense to enhance your current environmental services protocol. Facilities turn to this powerful, dynamic UV device for an advanced level of room cleaning—within a rapid amount of time. Empower your team with an easy-to-use disinfection system that targets surfaces and air simultaneously.

### Reliable performance

- Kills pathogens<sup>1-5</sup> on hard surfaces with powerful proprietary technology at real-life distances
- Disinfects the air at a rate of 250 cu ft per minute
- Conveniently select the cycle (5, 10 and 15 minutes) with one-click
- Features eight custom-built UVC germicidal bulbs to disinfect the room
- Provides real-time quality assurance data and tracks device usage with cloud-based reporting software
- Verify the effective dosage (100mJ/cm<sup>2</sup>) using UVC dosimeter cards to achieve effective reduction of pathogens

Item No.	Description	Pkg.
EVSUVSP1	Spectra 1000 UV Machine Capital Option	1 ea
EVSUVSP1S	Spectra 1000 UV Machine Subscription Option	1 ea
EVSUVSPSERV	Spectra 1000 Extended Warranty	1 ea



Specifically designed for hard surface and air disinfection.

**Patent No: US 8,791,441**

Maximizes UV-C output throughout the disinfection cycle.

**Patent No: US 8,791,441**

1–2 minute setup with 5–15 minute disinfection cycles.

Cloud-based reporting software provides:

- Real-time quality
- Assurance data

7.5 lbs push force with minimal moving parts for enhanced reliability.

Easily link two units for easy maneuverability and faster room turnover.

### Surface efficacy

**99.98%\*\*** against *C. auris*<sup>1</sup>     **99.983%\*\*\*** of *C. difficile* spores<sup>5</sup>     **99.999%\*\*\*** against MRSA<sup>5</sup>     **99.993%†** against Ebola surrogate<sup>2</sup>

### Air efficacy

**99.998%††** against *C. cladosporioides*<sup>3</sup>     **99.998%††** against *E. coli*<sup>4</sup>     **99.999%††** against MS2 Bacteriophage<sup>4</sup>     **99.999%††** against *S. aureus*<sup>4</sup>

References: 1–5. Data on file.

\* This product is not a medical device and is not intended for use in the disinfection or sterilization of medical devices. It is designed solely for use as a supplemental cleaning step to help reduce pathogens on hard, non-porous surfaces and in the air. This product is not a substitute for other required disinfection protocols and should be used as part of a comprehensive cleaning routine. Always follow all relevant cleaning and disinfection guidelines for your specific environment.

\*\* Tested at 3 feet above the floor and at a distance of 5 feet for 10 minutes.

\*\*\* Tested at floor level, facing the device and at a distance of 5 feet for 5 minutes.

† Tested at floor level, horizontal and at a distance of 5 feet for 5 minutes.

†† Tested at floor level for 15 minutes.

### Specifications

<b>Height</b>	6.14 ft (1870 mm)
<b>Width</b>	1.96 ft (598 mm)
<b>Depth</b>	2.41 ft (735 mm)
<b>Weight</b>	125 lbs (56.69 kg)
<b>Push Force</b>	7.5 lbs (3.402 kg)
<b>Amps</b>	11
<b>Volts</b>	120

# Portable Surface Disinfection Systems

## S400 Portable Air Disinfection Devices\*

- Effective against specific viruses and bacteria less than 0.3 micron in size<sup>1</sup>
- Disinfects a standard 800 cu ft room in 30 minutes
- Advanced 3 stage carbon, HEPA and UV system
- Laboratory tested kill rate of a minimum of 99.9% of tested airborne virus, bacteria, and mold with high CFM rating<sup>2</sup>
- Quiet 24/7 UVC air scrubbing; safe for patients and staff to be in the room

Item No.	Description	Pkg.
EVSUVAIR	S400 Portable Air Disinfection Device	1 ea
EVSUVAIRSERV	S400 Portable Air Disinfection Device Annual Filter Replacement Kit	1 ea
EVSUVAIRHEP	HEPA Filter Replacement, S400	1 ea



EVSUVAIR

## S200 Portable Air Disinfection System\*

- Air disinfection system with UV-C technology is effective against specific viruses and bacteria less than 0.3 micron in size
- 270° system circulates air at up to 200 cu ft per minute (CFM)<sup>3</sup>
- Superior odor and VOC removal
- Safe for occupied spaces

Item No.	Description	Pkg.
EVSUVAIR2	S200 Portable Air Disinfection/Purifier Device	1 ea
EVSUVAIRSERV2	S200 Portable Air Disinfection Device Annual Filter Replacement Kit	1 ea



EVSUVAIR2

References: 1-3. Data on file.

\*This product is not a medical device and is not intended for use in the disinfection or sterilization of medical devices. It is designed solely for use as a supplemental cleaning step to help reduce pathogens in the air. This product is not a substitute for other required disinfection protocols and should be used as part of a comprehensive cleaning routine. Always follow all relevant cleaning and disinfection guidelines for your specific environment.

# Portable Air Disinfection Systems

## ExpressPro Disinfecting Units

- Rapid UV disinfection station for busy work environments with individual and shared-use devices (phones, tablets, etc) that require quick, effective, and consistent disinfection\*
- 99.9% reduction in 30 seconds for the following pathogens: *C. difficile*, MRSA<sup>1</sup>
- Touchless operation
- 360° disinfection
- OLED display for any product instructions or notifications

Item No.	Description	Pkg.
EVSUVEXPRO	ExpressPro Disinfection Unit	1 ea
EVSUVEXPDS	Desk Stand, ExpressPro	1 ea
EVSUVEXPRS	Portable Roller Stand, ExpressPro	1 ea
EVSUVEXPRO2	ExpressPro Unit, Desk Stand Included	1 ea

\*This product is not a medical device and is not intended for use in the disinfection or sterilization of medical devices. It is designed solely for use as a supplemental cleaning step to help reduce pathogens on hard, non-porous surfaces. This product is not a substitute for other required disinfection protocols and should be used as part of a comprehensive cleaning routine. Always follow all relevant cleaning and disinfection guidelines for your specific environment.

Reference: 1. Data on file.



## UV-C Dosimeters

- Provide a visual indication of germicidal irradiation at four dose levels: 25, 50, 75 and 100 mJ/cm<sup>2</sup> for optimal UV-C disinfection
- Dots react to exposure from UV-C devices at 254 nm and change color to indicate the intensity of the dose delivered
- After exposure the accumulated dose can be determined using the included Color Reference Chart
- For best results, take exposure readings immediately after a disinfection cycle
- Dots are 1" diameter with adhesive backing

Item No.	Description	Pkg.
EVSUVC254DOT	UVC 254 Dot Dosimeters	10/bx
EVSUVC254DOTH	UVC 254 Dot Dosimeters	25/ea
EVSUVC254TRI	UVC 254 Tri Card, 25 Dosimeters, Chart, Pouch	10/bx
EVSUVC254TRIH	UVC 254 Tri Card, 25 Dosimeters, Chart, Pouch	25/ea

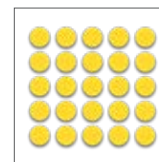

EVSUVC254DOT

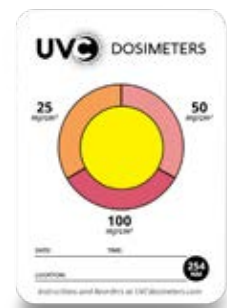

EVSUVC254TRI

# Air Fresheners

## Medline Solid Passive Air Deodorizers

- One refill lasts up to 60 days
- Each refill covers up to 6,000 cubic feet

Item No.	Description	Pkg.
EVSAIRDISP1	Solid Dispenser, 2.48"L 2.76"W 5.67"H, Black	1 ea
EVSAIR1	Solid Freshener, Apple Orchard	6/cs
EVSAIR2	Solid Freshener, Cucumber Melon	6/cs
EVSAIR4	Solid Freshener, Ocean Spray	6/cs
EVSAIR5	Solid Freshener, Citrus Mango	6/cs
EVSAIR6	Air Freshener, Lavender and Geranium	6/cs
EVSAIR7	Air Freshener, Bergamot and Sandalwood	6/cs
EVSAIR8	Air Freshener, Sea Salt and Bamboo	6/cs
EVSAIR9	Air Freshener, Linen Breeze	6/cs



EVSAIRDISP1



EVSAIR4

## Solid Air Freshener Dispenser

- High-quality fragrance delivery for up to 30 days, covering up to 3,500 cubic feet
- EVA material for optimum fragrance performance
- Recyclable, cost effective, and VOC exempt

Item No.	Description	Pkg.
EVSAIR5E	30-day Citrus and Mango Air Freshener	12/cs



EVSAIR5E

## Medline Urinal Screen Air Freshener

- One screen lasts up to 30 days

Item No.	Description	Color	Pkg.
EVSSCREEN5A	Urinal Screen, 7" x 7", Citrus Mango	Yellow	10/cs



EVSSCREEN5A

## Clip and Go Air Freshener

- Large internal surface area for effective, high-quality fragrance performance
- Clip-and-go, clip-and-throw™ design—replace used dispenser with a brand new version using the same fixing
- Economical to run; no aerosols, batteries, fans or propellants—just natural airflow

Item No.	Description	Pkg.
EVSAIRSHELL7	Air Freshener, Bergamot and Sandalwood	6/cs



EVSAIRSHELL7

# Soap and Hand Hygiene Products



# Hand Soaps

## Spectrum Lotion Soaps with Aloe Vera

- Gently moisturize and clean hands
- Contain aloe vera to condition skin

Item No.	Description	Pkg.
HHSP04	4-oz Bottle	12/cs
HHSP75	7.5-oz Bottle	12/cs
HHSP16	16-oz Bottle	12/cs
HHSP1000	1,000 mL for Dispenser	4/cs
HHSPG	1-gal Jug	4/cs



HHSP series

## Spectrum Antibacterial Foaming Hand Soaps

- Helps kill harmful germs
- Active ingredient: 0.13% benzalkonium chloride (BZK)
- Gentle enough for everyday use

Item No.	Description	Pkg.
HHABSP75FM	7.5-oz Bottle	12/cs
HHABSP1000FM	1,000-mL for Dispenser	4/cs



HHABSP75FM

HHABSP1000FM

## Spectrum Antibacterial Liquid Hand Soaps

- Active ingredient: 0.13% benzalkonium chloride
- Gentle enough for everyday use
- Product is intended for use on the body only

Item No.	Description	Pkg.
HHABSP04	4-oz Bottle	12/cs
HHABSP75	7.5-oz Bottle	12/cs
HHABSP16	16-oz Bottle	12/cs
HHABSP1000	1,000 mL for Dispenser	4/cs
HHABSPG	1-gal Jug	4/cs



HHABSP series

## Spectrum Foaming Hand Soaps

- Gentle enough for everyday use
- Moisturizing formula for soft hands

Item No.	Description	Pkg.
HHSP75FM	7.5 oz for Bottle	12/cs
HHSP1000FM	1,000 mL for Dispenser	4/cs



HHSP75FM

HHSP1000FM

# Hand Sanitizers

## Spectrum Advanced Foaming Hand Sanitizers

- Foaming hand sanitizer with 70% ethyl alcohol is effective at eliminating 99.99% of many common harmful germs and bacteria in as few as 15 seconds
- Foam formula evaporates quickly on hands
- CHG-compatible

Item No.	Description	Pkg.
HH70F75	7.5-oz Bottle	12/cs
HH70F18	18-oz Bottle	12/cs
HH70F1000	1,000 mL for Dispenser	4/cs



HH70F series

## Spectrum Advanced Hand Sanitizer Gels

- Contains 70% ethyl alcohol along with aloe and vitamin E
- Gel formula evaporates quickly on hands

Item No.	Description	Pkg.
HH70GPACKET	0.08-oz Packet	2,000/cs
HH70G02	2-oz Bottle	48/cs
HH70G04	4-oz Bottle	24/cs
HH70G08	8-oz Bottle	12/cs
HH70G1000	1,000-mL Bottle	4/cs



HH70G series

## Spectrum Advanced Hand Sanitizer Wipe

- Contains 70% ethyl alcohol along with aloe and vitamin E
- Intended for use on the hands only

Item No.	Description	Pkg.
HH70W160	160 Wipes/Container	6/cs



HH70W160

## Spectrum Fragrance-Free Hand Sanitizer Gels

- Fragrance-free gel contains 62% ethyl alcohol, aloe vera and vitamin E
- Gel formula evaporates quickly on hands

Item No.	Description	Pkg.
HH62G02	2-oz Bottle	48/cs
HH62G1000	1,000 mL for Dispenser	4/cs



HH62G02

HH62G1000

# Dispensers and Stands

## Spectrum Manual Dispensers

- Manual front-push dispenser holds the Spectrum line of hand sanitizers
- Also compatible with Medline gel hand sanitizers

Item No.	Description	Pkg.
MANDISPB	Black	6/cs
MANDISPW	White	6/cs



MANDISPB



MANDISPW

## Spectrum Automatic Dispensers

- Dispenser holds the Spectrum line of hand sanitizers as well as the Medline gel hand sanitizers
- Hands-free dispenser automatically dispenses the correct amount of sanitizer

Item No.	Description	Pkg.
AUTODISPB	Black	1 ea
AUTODISPW	White	1 ea



AUTODISPB



HHSTANDW



AUTODISPW

## White Hand Hygiene Floor Stand

- Compatible with Spectrum AUTODISPB, AUTODISPW and Stirillium LXT10AUTO

Item No.	Description	Pkg.
HHSTANDW	White	1 ea



# Textiles

# Quality and value create a winning combination

Our recommended product mix for a standard healthcare bed that gives you the “biggest bang” for your budget dollars while enhancing patient care

**A** **FITTED SHEET**  
**Medline Soft-Span™ Knitted Contour Sheet with 4-Way Stretch**  
 MDTNC5L19



**B** **UNDERPAD**  
**PerforMAX™ LT Reusable Underpad**  
 MDTIU7SEFBLU



**E** **BLANKET**  
**Herringbone Spread Blanket**  
 MDTSB4B30WED

**C** **DRAW SHEET, FLAT SHEET AND PILLOWCASE**  
**Medline Interblend™ Percale Linens**  
**D** MDTFS4P15: Flat Sheet  
 MDTPC4P34Z: Pillowcase



**F** **PILLOW**  
**Ovation® Pillow**  
 MDT219860



# Prewashed and packaged linens for any emergency



## Ready-to-Use Textile Program

**Prepare for severe weather, pandemics, staff shortages or unforeseen disruptions in your laundry service with Medline's Ready-to-Use Textile Program.** This program provides linens processed to Healthcare standards, protected and packaged for use anytime, anywhere. It's a simple way to keep your operation moving and avoid costly delays in service.

- Complete solution for:
  - Labor constraints
  - Equipment issues
  - Disaster preparedness
  - Onboarding new facilities
- Pre-laundered, prepackaged and ready-to-use linens
- Helps laundries, hospitals, nursing homes, governmental agencies and alternate care avoid business disruptions

### Prewashed Linens

Item No.	Description	Pkg.
MDTWC4B16PW	Washcloth, 12" x 12", 1 lb, Blended	400/cs
MDTBT4B80PW	Bath Towel, 24" x 48", 8 lb, Blended	50/cs
MDTB3B17PW	Bath Blanket, 70" x 90", 1.7 lb, Unbleached Blended	24/cs
MDTFS6S08PW	Flat Sheet, 66" x 108", Micropoly	48/cs
MDTFS6P08PW	Flat Sheet, 66" x 108", Heavyweight Percal	48/cs
MDTNC6S27PW	Envelope Contour Sheet, 30" x 92" x 15", 27 oz	36/cs
MDTPC6S34PW	Pillowcase, 42" x 34", Micropoly	210/cs
MDTPC6P34PW	Pillowcase, 42" x 34", Heavyweight Percal	210/cs
MDTPB3B400W	Baby Blanket	140/cs
MDTPG2ROLSNOPW	Patient Gown, 55% Cotton/45% Polyester, Regular Sleeves, 64" Sweep, 43" Length, Snowflake Print	72/cs

**You can't predict emergencies, but you can plan for them.** For more information on this special textile program, contact your Medline Representative today, or call 1-800-MEDLINE.

# Pillows

## Medsoft Pillows



- White soft vinyl ticking, wipe clean
- Vacuum-packed for easier delivery and storage and 70% compressed to ship
- Please allow 4 hours for pillow to fully expand

Item No.	Description	Pkg.
MDT219684	18" x 24", White, 16 oz/ea	20/cs
MDT219683	20" x 26", White, 18 oz/ea	12/cs



MDT219683

## EverLuxe Wipeable Reusable Pillows



- Wipeable, fluid-resistant outer polyester material
- Vacuum packed for smaller cartons to maximize your storage and reduce cardboard waste
- Luxury fill for enhanced patient comfort and support
- Please allow 4 hours for pillow to fully expand

Item No.	Description	Pkg.
MDT219777	20" x 26", Yellow	12/cs
MDT219778	18" x 24", Yellow	20/cs



MDT219777

## Ovation® Pillows



- Wipeable with polypropylene ticking
- Priced to meet your budget
- Vacuum packed, which results in smaller cartons for delivery and storage
- Please allow 4 hours for pillow to fully expand

Item No.	Description	Pkg.
MDT219860	20" x 26", White	12/cs
MDT219861	18" x 24", White	20/cs
MDT219885	20" x 26", Blue	12/cs
MDT219886	18" x 24", Blue	20/cs



MDT219860

Best ✓✓✓ Better ✓✓ Good ✓

# Woven Sheets and Pillowcases

## Medline Interblend™ Percalé Linens



- Hydrogen peroxide bleached for whiter color and softer feel
- Outstanding comfort and durability
- Long wearing, wrinkle-resistant for clean, crisp appearance
- Intimate blend of 55% cotton/45% polyester percale fabric

Item No.	Description	Pkg.
MDTCS4P84	Contour Sheet, 36" x 84" x 9"	5 dz/cs
MDTCS4P80	Contour Sheet, 36" x 80" x 9"	5 dz/cs
MDTDS4P81	Draw Sheet, 54" x 81"	5 dz/cs
MDTDS4P72	Draw Sheet, 54" x 72"	5 dz/cs
MDTDS4P72Z	Draw Sheet, 54" x 72"	2 dz/cs
MDTFS4P15	Flat Sheet, 66" x 115"	5 dz/cs
MDTFS4P08	Flat Sheet, 66" x 108"	5 dz/cs
MDTFS4P04	Flat Sheet, 66" x 104"	5 dz/cs
MDTFS4P15N	Flat Sheet, 60" x 115"	5 dz/cs
MDTFS4P08N	Flat Sheet, 60" x 108"	5 dz/cs
MDTFS4P04N	Flat Sheet, 60" x 104"	5 dz/cs
MDTR1692219AF	Flat Sheet, 66" x 108", Accordion-folded	5 dz/cs
MDTPC4P34	Pillowcase, 42" x 34"	12 dz/cs

Additional low delivery units available.



Medline interblend percale linens series.

## Polybright® Micropoly Sheets

- Synthetic, reusable linens have a bright white appearance wash after wash
- Brightness of sheet helps improve facility perception; heavy sheet weight helps improve patient experience
- Brushed micropoly is super soft to the touch
- Faster drying time compared to blended fibers for reduced utility costs
- Durable and stain resistant

Item No.	Description	Pkg.
MDTDS6S72	Draw Sheet, 54" x 72"	5 dz/cs
MDTFS6S00	Flat Sheet, 66" x 100"	5 dz/cs
MDTFS4S04	Flat Sheet, 66" x 104", 2.7 oz/yd	2 dz/cs
MDTFS6S04	Flat Sheet, 66" x 104"	5 dz/cs
MDTFS6S08	Flat Sheet, 66" x 108"	5 dz/cs
MDTPC4S34	Pillowcase, 42" x 34", 2.7 oz/yd	2 dz/cs
MDTPC6S34	Pillowcase, 42" x 36"	12 dz/cs



MDTFS6S08

Best ✓✓✓ Better ✓✓ Good ✓

# Woven Sheets and Pillowcases

## Medline Classic Muslin Linens

- Hydrogen peroxide bleached for whiter color and softer feel
- Durable blend of 55% cotton/45% polyester muslin fabric

Item No.	Description	Pkg.
MDTCS4M84	Contour Sheet, 36" x 84" x 9"	5 dz/cs
MDTCS4M80	Contour Sheet, 36" x 80" x 9"	5 dz/cs
MDTDS4M81	Draw Sheet, 54" x 81"	5 dz/cs
MDTDS4M72	Draw Sheet, 54" x 72"	5 dz/cs
MDTFS4M15	Flat Sheet, 66" x 115"	5 dz/cs
MDTFS4M08	Flat Sheet, 66" x 108"	5 dz/cs
MDTFS4M04	Flat Sheet, 66" x 104"	5 dz/cs
MDTFS4M04N	Flat Sheet, 60" x 104"	5 dz/cs
MDTPC4M34	Pillowcase, 42" x 34"	12 dz/cs

Additional low delivery units available.



Lightweight,  
breathable  
and easy to  
launder



Medline classic muslin linen series

# Knitted Sheets and Pillowcases

## Medline Stretcher Sheets

- Virtually wrinkle-free, no ironing required
- PerforMAX™ material is a blend of synthetic fibers that fade less, resist stains, shrink less and maintain their shape
- Cut and sewn to the unique contour of stretcher sheets

Item No.	Description	Pkg.
MDTNC7S18BLU	PerforMAX, 100% Polyester, Blue, 18 oz, 24" x 74" x 12"	5 dz/cs
MDTNC7S14BLU	PerforMAX, 100% Polyester, Blue, 14 oz, 24" x 70" x 9"	5 dz/cs
MDTNC6S16BLU	Soft-Fit Knitted Fitted Stretcher Sheet, 100% Polyester, Blue, 16 oz	5 dz/cs
MDTNC4J15GRE	Soft-Fit, 55% Cotton/45% Polyester, Green, 21 oz, 28" x 78" x 9"	5 dz/cs
MDTNC5J12BLU	Soft-Fit, 55% Cotton/45% Polyester, Blue, 12 oz, 30" x 80" x 8"	5 dz/cs
MDTNC4J10BLU	Jersey, 55% Cotton/45% Polyester, Blue, 10 oz, 24" x 72" x 12"	5 dz/cs
MDTNC4J10WHT	Jersey, 55% Cotton/45% Polyester, White, 10 oz, 24" x 72" x 12"	5 dz/cs



Stretcher Sheets



MDTNC5J12BLU

Best ✓✓✓ Better ✓✓ Good ✓

# Knitted Sheets and Pillowcases

## Medline Soft-Span™ Knitted Sheets with 4-Way Stretch



- Fit mattresses up to 42" wide and 88" long
- Reusable sheets are made with strong spandex fibers for exceptional durability and reduced occurrence of pinholes
- Stronger elasticity to fit most sizes of healthcare mattresses
- Excellent memory retention allows the sheets to cling to the mattress
- 55% combed cotton/41% polyester/4% spandex

Item No.	Description	Pkg.
MDTNC5L24	35" x 74" x 14", White with Red Stitching, 24 oz/dz	3 dz/cs
MDTNC5L21	35" x 74" x 14", White with Red Stitching, 21 oz/dz	3 dz/cs
MDTNC5L19	35" x 74" x 14", White with Red Stitching, 19 oz/dz	3 dz/cs

Additional low delivery units available.



MDTNC5L24

## Medline's Soft-Fit Knitted Sheets



- Exceptional patient comfort
- Knitted sheets come out of the dryer virtually wrinkle-free with no need for ironing
- Constructed with spandex in the bias to provide an even better fit
- All Soft-Fit knitted sheets have a 14" gusset

Item No.	Description	Pkg.
MDTNC4J24	Contour Sheet, 35" x 84" x 14", 55% Cotton/45% Polyester, White, 24 oz/dz	5 dz/cs
MDTNC4J21	Contour Sheet, 36" x 84" x 14", 55% Cotton/45% Polyester, White, 21 oz/dz	5 dz/cs
MDTNC4J19	Contour Sheet, 35" x 84" x 14", 55% Cotton/45% Polyester, White, 19 oz/dz	5 dz/cs
MDTNC4J15	Contour Sheet, 36" x 84" x 13", 55% Cotton/45% Polyester, White, 15 oz/dz	5 dz/cs
MDTNC4J13	Contour Sheet, 35" x 84" x 13", 55% Cotton/45% Polyester, White, 13 oz/dz	5 dz/cs
MDTFS4J104	Flat Sheet, 60 x 104, 55% Cotton/45% Polyester, White, 14 oz/dz	5 dz/cs
MDTFS4J14	Fitted Flat Sheet, 55% Cotton/45% Polyester, White, 14.5 oz/dz	5 dz/cs
MDTPC4J03	Pillowcase, 55% Cotton/45% Polyester, White, 3 oz/ea	12 dz/cs



Medline's Soft-Fit Contour Sheets Series

Best ✓✓✓ Better ✓✓ Good ✓

# Knitted Sheets and Pillowcases

## PerforMAX™ Envelope Contour Sheets



- 100% polyester with cotton-like softness
- Wrinkle-resistant surface moves with patient to help reduce friction and shear
- Long-lasting, stain-resistant and maintains bright white appearance longer

Item No.	Description	Pkg.
MDTNC8S27	30" x 92" x 15", MJS, 27 oz	3 dz/cs
MDTNC8S21	30" x 92" x 15", 21 oz	3 dz/cs
MDTNC6S27	30" x 92" x 15", RS, 27 oz	3 dz/cs
MDTNC8S33	48" x 88" x 14", Bariatric, 33 oz	3 dz/cs

Additional low delivery units available.



## PerforMAX™ Contour Sheets



- 100% stain-resistant polyester fibers easily wash away natural or water-based stains
- Maintains bright white appearance even after repeated washings
- Minimal shrinkage allows for greater longevity

Item No.	Description	Pkg.
MDTNC7S24	48" x 88" x 14", 24 oz	3 dz/cs

Additional low delivery units available.



### PerforMAX™ Envelope Contour Sheets

fit a wide range of mattress sizes from 32" x 80" through 42" x 88" and every size in between



Best ✓✓✓

Better ✓✓

Good ✓

# Blankets

## Herringbone Spread Blankets

- Snagless Herringbone knit reduces replacement costs
- Soft and comfortable, tight weave retains heat; napped on both sides
- Low processing cost, lightweight 55% cotton/45% polyester

Item No.	Description	Pkg.
MDTSB4B30WED	70" x 108", Wedgewood Blue, 3 lb/ea	1 dz/cs
MDTSB4B30CEL	70" x 108", Celery, 3 lb/ea	1 dz/cs
MDTSB4B30ANT	70" x 108", Antique Rose, 3 lb/ea	1 dz/cs
MDTSB4B30CAP	70" x 108", Cappuccino Beige, 3 lb/ea	1 dz/cs
MDTSB4B30LIN	70" x 108", Linen, 3 lb/ea	1 dz/cs
MDTSB4B30WHI	70" x 108", White, 3 lb/ea	1 dz/cs



MDTSB4B series

## Unbleached Bath Blankets

- Made from exceptional yarns
- Napped on both sides for a soft flannel surface with minimal pilling
- Soft, warm, comfortable and highly absorbent

Item No.	Description	Pkg.
MDTBB2B11R	60" x 85", 82% Cotton/18% Polyester, 1.1 lb	48/cs
MDTBB3B14RN	60" x 85", 82% Cotton/18% Polyester, 1.4 lb	48/cs
MDTBB4B14R	70" x 90", 55% Cotton/45% Polyester, 1.4 lb	48/cs
MDTBB3B14T	70" x 90", 82% Cotton/18% Polyester, 1.4 lb	24/cs
MDTBB3C14T	70" x 90", 100% Cotton, 1.4 lb	24/cs
MDTBB3B17R	70" x 90", 82% Cotton/18% Polyester, 1.7 lb	48/cs
MDTBB3B17T	72" x 90", 82% Cotton/18% Polyester, 1.75 lb	24/cs
MDTBB3C17T	72" x 90", 100% Cotton, 1.75 lb	48/cs
MDTBB5B20R	70" x 90", 82% Cotton/18% Polyester, 2 lb	48/cs



MDTBB3B14T

## Serpentine Snag-Less Thermal Spread Blankets

- More durable compared to traditional thermals, which saves money over time
- Tight weave prevents snags and provides outstanding warmth
- Choose from 100% cotton or 55% cotton/45% polyester

Item No.	Description	Pkg.
MDTTB4C24WHIR	72" x 96", 100% Cotton, 2.4 lb	24/cs
MDTTB4B23WHIR	66" x 90", 55% Cotton/45% Polyester, 2.3 lb	24/cs



Best ✓✓✓ Better ✓✓ Good ✓

# Reusable Underpads

## Quick Dry Poly Laminated Reusable Underpad



- Face fabric on underpads quickly wicks fluid and is dry to the touch in minutes
- Unique blend of fibers in the soaker layer help absorb and distribute fluid more effectively
- Breathable polyurethane film helps block fluid, but allows moisture vapor to escape, creating a cooler, drier and more comfortable patient environment
- Bonded construction thins the pad for less bulkiness with no decrease in absorption
- Lays flat with no bunching or rolling

Item No.	Description	Pkg.
MDTIU8SEFBLU	34" x 36", 100% Brushed Polyester, Green Face/Blue Barrier, Heavy	1 dz/cs



## PerforMAX™ LT Reusable Underpad



- Breathable polyurethane film helps block fluid, but allows moisture vapor to escape, creating a cooler, drier and more comfortable patient environment
- Swift-Dry top layer wicks fluid in quickly and moves it to the center core
- Super absorbent core disperses fluid throughout the pad so the top feels dryer quicker
- Bonded construction thins the pad for less bulkiness with no decrease in absorption
- Lays flat with no bunching or rolling

Item No.	Description	Pkg.
MDTIU7SEFBLU	34" x 36", Poly, Moderate Soaker, Green Face	2 dz/cs



## PerforMAX™ Reusable Laminate Vinyl Underpads



- Contains all the absorbent and stain-free features of the PerforMAX LT, but is fabricated with a laminate vinyl film instead of the polyurethane layer in the PerforMAX LT
- Swift-Dry top layer helps wick fluid in quickly and moves it to the center core
- Super-absorbent core helps disperse fluid throughout the pad so the top feels dryer quicker
- Bonded construction helps "thin" the pad for less bulkiness with little decrease in absorption
- Lays flat with minimal bunching or rolling; resists stains for more uses per pad

Item No.	Description	Pkg.
MDTIU7SEFGRE	34" x 36", Laminated, 100% Polyester, Moderate Soaker, White Face	2 dz/cs
MDTIU7SDFBLU	32" x 36", Laminated, Twill, Moderate Soaker, White Face	2 dz/cs



Best ✓✓✓ Better ✓✓ Good ✓

# Reusable Underpads

## Sofnit 300 Tartan Traditional Reusable Underpad

- Durable, comfortable plaid Ibex® facing conceals staining
- Vinyl knit barrier withstands heavy demands of multiple washing and drying cycles
- Stays soft and leak-resistant
- 80% cotton/20% polyester, polyester/rayon soaker, Green barrier



Item No.	Description	Pkg.
MDTIU3XEFHUN	34" x 36", Plaid Face/Green Barrier, Moderate	2 dz/cs



MDTIU3XEFHUN

## Sofnit 300 Reusable Underpads

- Durable, comfortable twill facing resists staining
- Vinyl knit barrier withstands heavy demands of multiple washing and drying cycles
- Stays soft and leak-resistant
- 55% cotton/45% polyester, moderate polyester/rayon soaker, Pink vinyl knit barrier



Item No.	Description	Pkg.
MDTIU3TABPNK	18" x 24", White Face/Pink Barrier, Moderate	2 dz/cs
MDTIU3TEFPNK	34" x 36", White Face/Pink Barrier, Moderate	2 dz/cs
MDTIU3TEFPNKZ	34" x 36", White Face/Pink Barrier, Moderate	1 dz/cs
MDTIU3TEIPNK	34" x 38", White Face/Pink Barrier, Moderate	2 dz/cs



MDTIU3TEFPNK

## Sofnit® 200 Reusable Underpads

- Economical and durable
- Cotton/polyester twill face fabric remains soft for patient comfort and offers high-heat resistance during drying
- Lightweight soaker allows for processing efficiencies and remains leak resistant



Item No.	Description	Pkg.
MDTIU2TCFPEA	30" x 36" Light Soaker, White Face	2 dz/cs
MDTIU2TDFPEA	32" x 36", Light Soaker, White Face	2 dz/cs
MDTIU2TEIPEA	34" x 48", Light Soaker, White Face	2 dz/cs



MDTIU2TDFPEA

Best ✓✓✓ Better ✓✓ Good ✓

# Mattress Covers and Encasements

## What is the difference between covers and encasements?

### Covers

- Fits like a traditional contour sheet to protect top of mattress
- Easy application and removal for cleaning
- Ideal for beds with higher patient/resident change over
- Protects mattress from wetness and staining
- Processes easily in a regular commercial-style machine or an industrial laundry

### Encasements

- Envelopes entire mattress in protection with zip closure and lock
- Ideal for long-term residents
- Allergen-blocking and bed bug protection, as well as water resistant to prevent wetness and staining
- Processes easily in a regular commercial-style machine (not intended for industrial laundry)

## Frosthite Cover and Encasements

- First defense to improve the longevity of your mattress
- 3-gauge vinyl
- Economical method to protect mattresses and pillows from fluid penetration



Item No.	Description	Pkg.
MDT219403	Mattress Cover with Contour, 36" x 80" x 9", 0.75 lb	1 dz/cs
MDT219409	Mattress Encasement with Zipper, 36" x 80" x 9", 1 lb	1 dz/cs
MDT219411Z	Pillow Encasement with Zipper, 21" x 27", 0.25 lb	2 dz/cs



Medline's Frosthite Series

Best ✓✓✓ Better ✓✓ Good ✓

# Bath Towels

## Medline Fine Spun Towels



- Premium-grade 100% ring-spun cotton gives these terries a plush, luxurious look and feel
- Treated with hydrogen peroxide for a brighter White appearance
- Using our finest 16/1 ring-spun cotton, these terries are strong with a significantly softer hand to offer you the best in patient experience

Item No.	Description	Pkg.
MDTBT5C80R	Bath Towel, 24" x 48", 8 lb/dz	10 dz/cs
MDTBT5C10R	Bath Towel, 22" x 50", 10.5 lb/dz	10 dz/cs
MDTBT5C60R	Bath Towel, 22" x 44", 6 lb/dz	25 dz/bl
MDTBT5C55R	Bath Towel, 20" x 40", 5.5 lb/dz	25 dz/bl
MDTHT5C30R	Hand Towel, 16" x 27", 3 lb/dz	50 dz/bl
MDTWC5C16SR	Washcloth, 12" x 12", 1 lb/dz	100 dz/bl
MDTWC5C16HR	Washcloth, 12" x 12", 1 lb/dz	50 dz/bl



## Medline Interblend Towels



- The ultimate soft and durable towels at affordable prices
- Ideal blend of 85% cotton/15% polyester
- Woven to last long and dry fast
- Includes 16/1 ring spun yarns in the construction for added strength and softness
- Treated with hydrogen peroxide for a brighter White appearance

Item No.	Description	Pkg.
MDTBT4B10R	Bath Towel, 24" x 50", 10 lb/dz	10 dz/cs
MDTBT4B80R	Bath Towel, 24" x 48", 8 lb/dz	10 dz/cs
MDTBT4B60R	Bath Towel, 22" x 44", 6 lb/dz	25 dz/bl
MDTBT4B55R	Bath Towel, 20" x 40", 5.5 lb/dz	25 dz/bl
MDTHT4B30R	Hand Towel, 16" x 27", 3 lb/dz	50 dz/bl
MDTWC4B11HR	Washcloth, 12" x 12", 0.7 lb/dz	100 dz/bl
MDTWC4B16HR	Washcloth, 12" x 12", 1 lb/dz	100 dz/bl



## Medline Classic Cotton Terry Bath Towels



- 100% open-end cotton terries provide excellent absorbency and performance while meeting your budget
- Treated with hydrogen peroxide for a brighter White appearance

Item No.	Description	Pkg.
MDTBT3C80R	Bath Towel, 22" x 48", 8 lb/dz	10 dz/bl
MDTBT3C60R	Bath Towel, 22" x 48", 8 lb/dz	10 dz/bl
MDTBT3C55R	Bath Towel, 20" x 40", 5.5 lb/dz	25 dz/bl
MDTBT3C50R	Bath Towel, 20" x 40", 5 lb/dz	25 dz/bl
MDTBT3C40R	Bath Towel, 20" x 40", 4 lb/dz	25 dz/bl
MDTHT3C26R	Hand Towel, 16" x 27", 2.62 lb /dz	50 dz/bl
MDTWC3C16HR	Washcloth, 12" x 12", 1 lb/dz	100 dz/bl
MDTWC4C16HR	Washcloth, 12" x 12", 1 lb/dz	100 dz/bl

Stretch your budget dollars

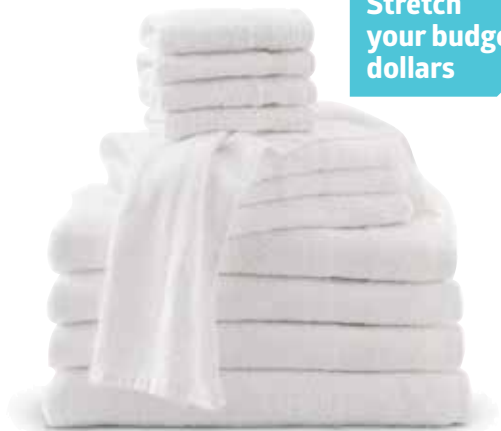

Best ✓✓✓ Better ✓✓ Good ✓

# Bath Towels

## Fibertone® Terries

- Specifically designed to withstand the harshness of commercial laundering
- Each color is entirely permanent and inherent to the product, which means no bleeding or fading
- Super-plush 86% cotton/14% polyester ring-spun terries add warmth, texture and an upscale look to any facility



Item No.	Description	Pkg.
MDTBT6B10*Z	Bath Towel, 24" x 50", 10.5 lb/dz	5 dz/cs
MDTWC6B16*T	Washcloth, 12" x 12", 1 lb /dz	25 dz/cs
MDTHT6B30*Z	Hand Towel, 16" x 27", 3 lb/dz	10 dz/cs

\*Add ECR for Ecru, BLU for Light Blue, or SEA for Seafoam Green



## Vibrance Terries

- Fashionable solid-colored terries
- Vat dyed for color richness
- Plush and luxurious look and feel
- All items in stock for faster shipping and delivery
- 100% ring-spun cotton



Item No.	Description	Pkg.
MDTBT5C55*	Bath Towel, 20" x 40", 5.5 lb/dz	5 dz/cs
MDTBT5C80*	Bath Towel, 24" x 48", 7.75 lb/dz	5 dz/cs
MDTWC5C16S*	Washcloth, 12" x 12", 1 lb/dz	10 dz/cs
MDTHT5C30*	Hand Towel, 16" x 27", 3 lb/dz	5 dz/cs

\*Add CRE for Cream or BLU for Slate Blue



Best ✓✓✓ Better ✓✓ Good ✓

# Utility Cloths

## Bar Mops

- Perfect for cleaning up spills and wiping down counters
- Made from 100% cotton
- 16" x 19"

Item No.	Description	Pkg.
MDTUT3C17WHIZ	Ribbed, White, 28 oz/dz	10 dz/cs
MDTUT3C18BLU	Blue Stripe, 30 oz/dz	50 dz/bl
MDTUT3C20GLD	Gold Stripe, 32 oz/dz	50 dz/bl



## Blue Utility Terry Cloth

- 100% cotton makes cloth more absorbent than a standard flat woven fabric
- Perfect for a variety of tasks

Item No.	Description	Pkg.
MDTWC3C08BLUR	11" x 11", 8 oz/dz	200 dz/bl



MDTWC3C08BLUR

# Clothing Protection

## Medline Tartan Print Adult Bibs



- 80% cotton/20% polyester with vinyl protective backing for the ultimate fluid protection
- Plaid Tartan print with Beige binding
- Excellent chest and lap protector

Item No.	Description	Pkg.
MDTAB3I33PLD	21" x 33", Hook-and-Loop Closure, 10 oz/ea	2 dz/cs
MDTAB4I33PLD	21" x 33", Snap Closure, 10 oz/ea	2 dz/cs



MDTAB3I33PLD

## EZ Tie Terrycloth Adult Bibs



- Generously cut from soft, 12-oz heavyweight terrycloth
- Cotton/polyester blend
- Cover a large surface area and offer extremely effective spill protection
- EZ tie closures last longer than snaps or hook-and-loop closures

Item No.	Description	Pkg.
MDTAB5B38WHI	21" x 38", 85% Cotton/15% Polyester, White with Blue Binding, 12 oz/ea	2 dz/cs
MDTAB5B41STP	22" x 41", 90% Cotton/10% Polyester, Multicolor Stripes with Blue Binding, 12 oz/ea	2 dz/cs



MDTAB5B38WHI



MDTAB5B41STP

## Medline Terrycloth Adult Bibs



- Soft, heavyweight 100% cotton terrycloth
- Effective spill protection
- Large surface area coverage

Item No.	Description	Pkg.
MDTAB3C34STP	17" x 34", Hook-and-Loop Closure, 100% Cotton, Pastel Stripe, 13 oz/ea	2 dz/cs
MDTAB4B33WHI	21" x 33", Snap-Closure, 85% Cotton/15% Polyester, White with Blue Binding, 10 oz/ea	2 dz/cs
MDTAB3B30WHI	18" x 30", Hook-and-Loop Closure, 85% Cotton/15% Polyester, White with White Binding, 10 oz/ea	2 dz/cs



MDTAB4B33WHI



MDTAB3C34STP

Best ✓✓✓ Better ✓✓ Good ✓

# Interiors



# Traditional Shower Curtains

Our traditional shower curtains generally require no change to your current protocols

## Medline 10-Gauge Shower Curtains

- Stocked, pre-cut and ready to ship for your immediate needs
- Extra-heavy duty 10-gauge vinyl provides durability and long-lasting use

Item No.	Size	Color	Pkg.
MITSC103672W	36"W x 72"L	White	12/cs
MITSC103672B	36"W x 72"L	Beige	12/cs
MITSC107272B	72"W x 72"L	Beige	12/cs

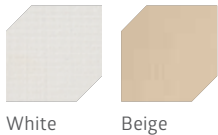

White

Beige



Shown in Beige (MITSC107272B)

## Spring Shower Collection

- Heavy-duty vinyl shower curtains are water-repellent and feature an embossed stripe pattern.
- Made from 8-gauge vinyl for durability

Item No.	Size	Color	Pkg.
SSQ36X72WHI	36"W x 72"L	White	1 ea
SSQ36X72BGE	36"W x 72"L	Beige	1 ea
SSQ72X72WHI	72"W x 72"L	White	1 ea
SSQ72X72BGE	72"W x 72"L	Beige	1 ea

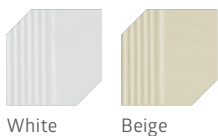

White

Beige



Shown in Beige (SSQ72X72BGE)

**Ships within  
7 to 10  
business  
days**

# Traditional Shower Curtains

## Spray Collection

- Economic shower curtain made of durable, 100% nylon
- Features sewn eyelet header

Item No.	Size	Color	Pkg.
SPQ36X72WHI	36"W x 72"L	White	1 ea
SPQ72X72WHI	72"W x 72"L	White	1 ea
SPQ72X72BEI	72"W x 72"L	Beige	1 ea



White



Beige



**Ships within  
7 to 10  
business  
days**

Shown in White (SPQ72X72WHI).

## Rain Collection

- Economical, .5" double-turn hem shower curtains feature an embossed taffeta pattern.
- Made from 6-gauge vinyl
- Metal grommets for added durability

Item No.	Size	Color	Pkg.
RAQ36X72WHI	36"W x 72"L	White	1 ea
RAQ36X72FRO	36"W x 72"L	Frosty	1 ea
RAQ36X72BGE	36"W x 72"L	Beige	1 ea
RAQ36X72GRN	36"W x 72"L	Green	1 ea
RAQ36X72BLU	36"W x 72"L	Blue	1 ea
RAQ72X72WHI	72"W x 72"L	White	1 ea
RAQ72X72FRO	72"W x 72"L	Frosty	1 ea
RAQ72X72BGE	72"W x 72"L	Beige	1 ea
RAQ72X72GRN	72"W x 72"L	Green	1 ea
RAQ72X72BLU	72"W x 72"L	Blue	1 ea



White



Frosty



Beige



Green



Blue



**Ships within  
7 to 10  
business  
days**

Shown in Blue (RAQ36X72BLU)

# Hookless Shower Curtains

## Raindance Collection

- Hookless 100% polyester shower curtains feature a sheer window that allows light into the shower for a feeling of space and security
- Water-resistant
- Ultrasonically cut bottom hem, magnet weighted
- Compatible with 1"-diameter shower rods only
- No liner necessary

Item No.	Size	Color	Pkg.
SHWRD42X74BG	42"W x 74"L	Beige	12/cs
SHWRD71X74WHT	71"W x 74"L	White	12/cs
SHWRD71X74BG	71"W x 74"L	Beige	12/cs



White



Beige



Shown in White (SHWRD71X74WHT)

Ships within  
**2 to 3**  
business days

## Rainshadow Collection

- Hookless 100% polyester shower curtains feature a subtle woven pattern that adds a contemporary feel to the design
- Water-resistant
- Ultrasonically cut bottom hem, magnet weighted
- Compatible with 1"-diameter shower rods only
- No liner necessary

Item No.	Size	Color	Pkg.
SHWRS71X74WHT	71"W x 74"L	White	12/cs
SHWRS71X74BG	71"W x 74"L	Beige	12/cs
SHWRS42X74WHT	42"W x 74"L	White	12/cs
SHWRS42X74BG	42"W x 74"L	Beige	12/cs
SHWRS71X80BG	71"W x 80"L	Beige	12/cs



White



Beige



Shown in Beige (SHWRS71X74BG)

Ships within  
**2 to 3**  
business days

# Hookless Shower Curtains

## Raindrop Collection

- Hookless, 8-gauge, heavyweight vinyl shower curtains are durable and long lasting—ideal for almost any healthcare environment
- Ultrasonically cut bottom hem, magnet weighted
- Compatible with 1"-diameter shower rods only

Item No.	Size	Color	Pkg.
SHWRP71X74WHT	71"W x 74"L	White	12/cs
SHWRP71X74BGE	71"W x 74"L	Beige	12/cs
SHWRP71X80WHT	71"W x 80"L	White	12/cs
SHWRP42X74BGE	42"W x 74"L	Beige	12/cs



White



Beige



Shown in White (SHWRP71X74WHT)

# Disposable Shower Curtains

## Cost-Effective Disposable Curtains

- For areas where there is an elevated risk of infection
- Temporary replacement while reusable curtains are being laundered
- Emergency curtains when inventory is depleted
- Cost-effective alternative to reusables
- Can be cut down from 90" to a custom height as needed

Item No.	Size	Color	Pkg.
SCD36X90WHI	36"W x 90"L	White	24/cs
SCD72X90WHI	72"W x 90"L	White	24/cs



White



Shown in White (SCD72X90WHI)

# Shower Curtain Accessories

**Ships within  
7 to 10  
business  
days**

## Shower Tension Rod

- Rust resistant
- Adjustable up to 72"
- Easy installation

Item No.	Description	Pkg.
KACTR4272	42"-72" Wide	6/cs

## Track with Carriers

- Durable, easy-to-install track system for smooth operation
- Available in sizes from 12" to 108" wide
- Includes carriers

Item No.	Description	Pkg.
SUP3FTSTR	Track System, 36" Wide	1 ea
SUP6FTSTR	Track System, 72" Wide	1 ea

\*For additional sizes, please contact your Medline Representative.

## Shower Stationary Rods

- Constructed of 1" seamless aluminum tubing
- Available in a variety of sizes (custom sizes available)

Item No.	Description	Pkg.
IFC70R3FT*	Stationary Shower Rod, 36" Wide	1 ea
IFC70R4FT*	Stationary Shower Rod, 48" Wide	1 ea
IFC70R5FT*	Stationary Shower Rod, 60" Wide	1 ea
IFC70R6FT*	Stationary Shower Rod, 72" Wide	1 ea
IFC70R7FT*	Stationary Shower Rod, 84" Wide	1 ea
IFC70R8FT*	Stationary Shower Rod, 96" Wide	1 ea
IFC70R9FT*	Stationary Shower Rod, 108" Wide	1 ea
IFC71B	Wall Mount Brackets	1 pr

\*Brackets and screws not included. To purchase, order IFC71B.

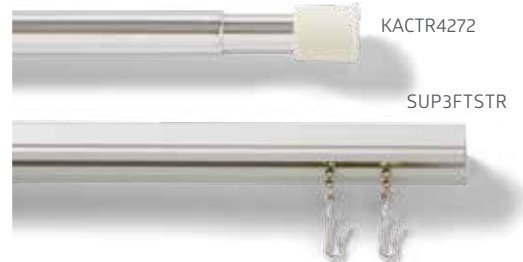

# Shower Curtain Accessories

**Ships within  
7 to 10  
business  
days**

## Shower Rings and Hooks

- Choose plastic rings, steel snap hooks or wire hooks with ball bearings to complement your décor.
- Heavy-duty closing hooks hold heavy vinyl curtains
- Metal hooks with seal shut design to prevent curtains from falling off during normal use

Item No.	Description	Pkg.
MCDKA9100C	Clear Plastic Shower Curtain Ring	1 dz
MCDKA9100W	White Plastic Shower Curtain Ring	1 dz
MCDCKA9100B	Beige Plastic Shower Curtain Ring	1 dz
MCDKA2000	Snap Pin Shower Curtain Hooks, for 1.5" Rod	1 dz
MCDKA151	Wire Shower Curtain Hooks with 4 Rollers, for 1" Rod	1 dz
MCDKA256	Wire Shower Curtain Hooks with 5 Rollers, for 1.5" Rod	1 dz
MCD114130C	Shower Curtain Carriers for Track System	1 ea

MOQ/small order fees apply.



# Reusable Cubicle Curtains

## Spring Frost Collection Traditional Cubicle Curtains

- Excellent stain and odor-release properties
- Traditional track attachment
- Curtains come complete with mesh sewn into fabric panel

Item No.	Description	Pkg.
MITQCSF104*	108" x 82"	1 ea
MITQCSF107*	144" x 82"	1 ea
MITQCSF108*	144" x 88"	1 ea
MITQCSF109*	144" x 94"	1 ea
MITQCSF113*	216" x 82"	1 ea
MITQCSF115*	216" x 94"	1 ea

\*Add color/pattern code at the end of item number: SPA, COK, BLM, OA

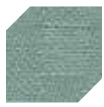

Spa (SPA)



Cookie (COK)

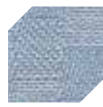

Blue Moon (BLM)



Oatmeal (OA)



Shown in Spring Frost Cookie (MITQCSF107COK)

For additional fabrics and sizes, visit us at <https://interiors.medline.com/>

# Reusable Cubicle Curtains

## Snap Panel System

- For easy installation, storage and changes
- Panels available in variety of colors, visit [interiors.medline.com](https://interiors.medline.com) for more information
- Number of panels determined by track length (see chart below)
- Mesh and fabric panels sold separately

## Snap Panel Fabrics

Item No.	Size	Color	Pkg.
MIT6RPCAOCHKE	66"W x 66"H	Canon Chalk	1 ea
MIT6RPMAMBRZE	66"W x 66"H	Mambo Breeze	1 ea
MIT6RPSFABLME	66"W x 66"H	Spring Frost Blue Moon	1 ea
MIT6RPSFAOATE	66"W x 66"H	Spring Frost Oatmeal	1 ea
MIT6RPSFASPAE	66"W x 66"H	Spring Frost Spa	1 ea
MIT6RPSFASGYE	66"W x 66"H	Spring Frost Stingray	1 ea
MIT6RPTLHRTE	66"W x 66"H	Trellis Hearth	1 ea
MIT6RPUTEDENE	66"W x 66"H	Uptown Eden	1 ea

## Mesh Panels

- All mesh panels use white mesh with White snaps
- A reusable top mesh is required for snap panel systems
- Stocked for quick shipments, please visit [interiors.medline.com](https://interiors.medline.com) for additional sizes

Mesh Width	Mesh Height		Item No.	Pkg.
	20"	28"		
66"	MIT6M066X20E	MIT6M066X28E		6/cs
124"	MIT6M124X20E	MIT6M124X28E		6/cs
184"	MIT6M184X20E	MIT6M184X28E		6/cs
242"	MIT6M242X20E	MIT6M242X28E		6/cs
300"	MIT6M300X20E	MIT6M300X28E		6/cs



Shown in Uptown Eden (SNAP66PUTEDEN)



## Determine the number of panels needed for your track length

Track Length	Mesh Width	Number of Panels
50"–60"	66"	1 panel
61"–112"	124"	2 panels
113"–167"	184"	3 panels
168"–220"	242"	4 panels
221"–272"	300"	5 panels

For additional fabrics and sizes, visit us at <https://interiors.medline.com/>

# Disposable Cubicle Curtains

## Traditional Track Attachment

- No laundering required
- Can be cut down from 99" to a custom height as needed

Item No.	Size	Pattern/Color	Pkg.
CCDE100X99UPT*	100"W x 99"H	Uptown	4/cs
CCD144X99LTTE	144"W x 99"H	Latte	4/cs
CCD144X99COR	144"W x 99"H	Coronado	4/cs
CCD144X99UPT	144"W x 99"H	Uptown	4/cs
CCD240X99LTTE	240"W x 99"H	Latte	4/cs
CCD240X99COR	240"W x 99"H	Coronado	4/cs
CCD240X99UPT	240"W x 99"H	Uptown	4/cs

\*Economy version, includes punched mesh



Shown in Latte (CCD144X99LTTE).



Latte  
(LTTE)

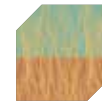

Coronado  
(COR)



Uptown  
(UPT)

For additional fabrics and sizes, visit us at <https://interiors.medline.com/>

# Disposable Cubicle Curtains

## Snap Panel Systems

- Easy installation; will fit existing track dimensions
- Panels available in variety of colors, visit [interiors.medline.com](https://interiors.medline.com) for more information
- Number of panels determined by track length (see chart below)
- Mesh and fabric panels sold separately

## Snap Panel Fabrics

Item No.	Size	Color	Pkg.
MIT6DARYCPRI	66"W x 66"H	Array	12/cs
MIT6DCANCOF	66"W x 66"H	Canon Coffee	12/cs
MIT6DMAMBRZ	66"W x 66"H	Mambo Breeze	12/cs
MIT6DMTLYMESA	66"W x 66"H	Motley	12/cs
MIT6DPETPAR	66"W x 66"H	Pet Parade	12/cs
MIT6DBCAPKRB	66"W x 66"H	Pink Ribbon/BCA	12/cs
MIT6DSEREN	66"W x 66"H	Serenity	12/cs
MIT6DTRLSHRTH	66"W x 66"H	Trellis	12/cs
MIT6DUPTOWN	66"W x 66"H	Uptown	12/cs
MIT6DUTNSPR	66"W x 66"H	Uptown Spring	12/cs
MIT6DUTNSUM	66"W x 66"H	Uptown Summer	12/cs
MIT6DUTNWNT	66"W x 66"H	Uptown Winter	12/cs
MIT6DBEIGE	66"W x 66"H	Beige	12/cs
MIT6DHZLWD	66"W x 66"H	Hazelwood	12/cs
MIT6DLATTE20	66"W x 66"H	Latte	20/cs

## Mesh Panels

- All mesh panels use white mesh with White snaps
- A reusable top mesh is required for snap panel systems

Mesh Width	Mesh Height		Pkg.
	20"	28"	
66"	MIT6M066X20E	MIT6M066X28E	6/cs
124"	MIT6M124X20E	MIT6M124X28E	6/cs
184"	MIT6M184X20E	MIT6M184X28E	6/cs
242"	MIT6M242X20E	MIT6M242X28E	6/cs
300"	MIT6M300X20E	MIT6M300X28E	6/cs



## Determine the number of panels needed for your track length

Track Length	Mesh Width	Number of Panels
50"–60"	66"	1 panel
61"–112"	124"	2 panels
113"–167"	184"	3 panels
168"–220"	242"	4 panels
221"–272"	300"	5 panels



**Ships within  
2 to 5  
business  
days**

Shown in Uptown Eden (MIT6DUPTOWN)

### Patterns



Array<sup>†</sup>  
(ARYCPRI)



Canon Coffee<sup>†</sup>  
(CANCOF)



Mambo Breeze<sup>†</sup>  
(MAMBRZ)



Motley<sup>†</sup>  
(MTLYMESA)



Pet Parade<sup>†</sup>  
(PETPAR)



Pink Ribbon/  
BCA  
(BCAPKRB)



Serenity  
(SEREN)



Trellis<sup>†</sup>  
(TRLSHRTH)



Uptown<sup>†</sup>  
(UPTOWN)



Uptown Spring<sup>†</sup>  
(UTNSPR)



Uptown Summer<sup>†</sup>  
(UTNSUM)



Uptown Winter<sup>†</sup>  
(UTNWNT)

### Solids



Beige<sup>†</sup>  
(BEIGE)



Hazelwood<sup>†</sup>  
(HZLWD)



Latte<sup>†</sup>  
(LATTE20)

**Note:** Colors are reproduced as faithfully as printing processes allow.

<sup>†</sup> These colors and patterns are included in the hybrid program. For more details on coordinating and matching options, please contact your Medline Representative or visit [interiors.medline.com](https://interiors.medline.com).

For additional fabrics and sizes, visit us at <https://interiors.medline.com/>

# Cubicle Curtain Accessories

Ships within  
**7 to 10**  
business days

## Supreme Track with Spool Carriers

- Durable, easy-to-install track system for smooth operation
- Track is available in 1-foot increments up to the desired length
- Includes 3 carriers (MTSUSPCAR) per foot
- Straight pieces ship with 2 end caps and 1 pull out
- Bend pieces ship with 2 splices

Item No.	Description	Pkg.
MTSUSP**FT	Supreme Track with Spool Carriers	1 ft and up
MTSUSP**FTW	Supreme Track with Spool Carriers, White Track	1 ft and up
MTSUSPCAR	Spool Carriers for Supreme Track	1 ea <sup>†</sup>
MTSUSP2X245	2' x 2' with 45° Bend	1 ea
MTSUSP2X290	2' x 2' with 90° Bend	1 ea

\*\*Replace asterisks with length.

† Minimum ordering quantities apply.

Note: screws/hardware not included.

MTSUSP\*\*FTW



MTSUSPCAR

## Additional Supreme Track Accessories

Item No.	Description	Pkg.
MTSUSPCAR	Spool Carrier	1 ea
MTSUCHCAR	Chain Carrier	1 ea
MTSUBKCAR	Breakaway Carrier	1 ea
MTSUSPCARHNL	Spool Carrier with Hook-and-Loop	1 ea
MTSUENDCAP	End Cap	1 ea
MTSUSPLICE	Splice	1 ea
MTSUPULLOUT	Pull Out/Snap Out	1 ea
MTACHNDRP**IN	Chain Drop	1 ea
MTAPVCDRP**IN	PVC Drop	1 ea
MTABATON**FT	Cubicle Curtain Baton	1 ea
MIT6DTIEBACK	Disposable Snap Tieback	20/cs

\*\*Replace asterisks with length.

MTSUENDCAP



MTSUPULLOUT



MTSUSPLICE

## Timestrip Indicators

- Automatically tracks the life of your curtain
- Available in 1-, 3- and 6-month time intervals
- Sized .75"W x 1.5"H to stick to instruction tag or any location on curtain
- Press-activated button begins filling white space with red ink to indicate when it's time to replace the curtain

Item No.	Description	Pkg.
TIMESTRIP1MO	1-Month Timestrips	100/bx
TIMESTRIP3MO	3-Month Timestrips	100/bx
TIMESTRIP6MO	6-Month Timestrips	100/bx



MIT6DTIEBACK



TIMESTRIP3MO

For additional track systems and accessories, contact your Medline Representative or visit [interiors.medline.com](http://interiors.medline.com).

# Quilts and Bedspreads

## Suede Touch Quilts

- Soft to the touch
- 5-oz per square yard
- Onion-stitched pattern
- Reversible and non-reversible options
- Throw or capped available
- Vacuum packaged protection for economical shipping
- 100% polyester fill
- Compliant with ISO 12952-1

### Reversible, Throw Style, Twin

Item No.	Size	Color	Pkg.
MITQSQPEBT	81"W x 110"L	Pebble Tan	1 ea
MITQSQZINT	81"W x 110"L	Zinfandel Red	1 ea
MITQSQPEAT	81"W x 110"L	Peacoat Blue	1 ea
MITQSQSAGT	81"W x 110"L	Sage Green	1 ea

### Non-Reversible, Capped Style, Twin

Item No.	Size	Color	Pkg.
MITQSQPEBC	71"W x 102"L	Pebble Tan	1 ea
MITQSQZINC	71"W x 102"L	Zinfandel Red	1 ea
MITQSQPEAC	71"W x 102"L	Peacoat Blue	1 ea
MITQSQSAGC	71"W x 102"L	Sage Green	1 ea

**Ships within  
2 to 5  
business  
days**



MITQSQSAGT

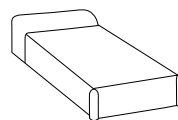

Throw style

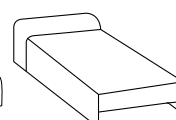

Capped style



Pebble Tan



Zinfandel Red



Peacoat Blue



Sage Green

## Passage Quilts

- Soft-Touch fabric
- Contemporary, channel-style stitching
- Reversible, throw style design

Item No.	Description	Color	Pkg.
MIQP70X110SMK	70" x 110"	Smoke	1 ea
MIQP70X110SND	70" x 110"	Sand	1 ea
MIQP70X110CRB	70" x 110"	Caribbean	1 ea
MIQP70X110SEA	70" x 110"	Sea	1 ea

**Ships within  
2 to 5  
business  
days**

Smoke

Sand

Caribbean

Sea



# Table Linens

## Essentials Collection—Basic Poly Tablecloths and Napkins

- Our most economical line is available in carefully selected colorways to complement most any décor

Item No.	Description	Pkg.
MITLNES235XXX	Essentials Tablecloth, 60" Round	1 ea
MITLNES241XXX	Essentials Tablecloth, 72" Round	1 ea
MITLNES218XXX	Essentials Tablecloth, 84" Round	1 ea
MITLNES222XXX	Essentials Tablecloth, 96" Round	1 ea
MITLNES224XXX	Essentials Tablecloth, 108" Round	1 ea
MITLNES202XXX	Essentials Tablecloth, 120" Round	1 ea
MITLNES248XXX	Essentials Tablecloth, 60" Square	1 ea
MITLNES240XXX	Essentials Tablecloth, 72" Square	1 ea
MITLNES260XXX	Essentials Tablecloth, 84" Square	1 ea
MITLNES223XXX	Essentials Tablecloth, 96" Square	1 ea
MITLNES229XXX	Essentials Tablecloth, 108" Square	1 ea
MITLNES271XXX	Essentials Tablecloth, 120" Square	1 ea
MITLNES204XXX	Essentials Napkins, 20" x 20"	12 ea

\*XXX" represents color designation. Add the 3-digit color code to item number when ordering.

Ships within  
**7 to 10**  
business  
days



## Signature Collection—Spun Poly Tablecloths and Napkins

- Heavyweight linens provide great durability, saturation and softness

Item No.	Description	Pkg.
MITLNSI235XXX	Signature Tablecloth, 60" Round	1 ea
MITLNSI241XXX	Signature Tablecloth, 72" Round	1 ea
MITLNSI218XXX	Signature Tablecloth, 84" Round	1 ea
MITLNSI222XXX	Signature Tablecloth, 96" Round	1 ea
MITLNSI224XXX	Signature Tablecloth, 108" Round	1 ea
MITLNSI202XXX	Signature Tablecloth, 120" Round	1 ea
MITLNSI248XXX	Signature Tablecloth, 60" Square	1 ea
MITLNSI240XXX	Signature Tablecloth, 72" Square	1 ea
MITLNSI260XXX	Signature Tablecloth, 84" Square	1 ea
MITLNSI223XXX	Signature Tablecloth, 96" Square	1 ea
MITLNSI229XXX	Signature Tablecloth, 108" Square	1 ea
MITLNSI271XXX	Signature Tablecloth, 120" Square	1 ea
MITLNSI204XXX	Signature Napkins, 20" x 20"	12 ea

\*XXX" represents color designation. Add the 3-digit color code to item number when ordering.

Ships within  
**7 to 10**  
business  
days



# Roller Shades

Modern designs manage light, privacy and energy efficiency



Easy  
to clean

## Smart design on a roll

Roller shades complement any décor, combining upscale design with low maintenance. They're a simple way to elevate the look of your space while delivering a major impact on comfort and energy efficiency.

## Control your environment

Manage the sun's heat and light with interior solar shade fabrics. Choose from a wide selection to help protect your furnishings from UV damage and improve patient and staff experience by reducing glare.

## Manage privacy

Tighter fabric weave shades keep light out and provide greater privacy for patient and exam rooms, offices and meeting rooms. Our dual shades offer a sunscreen fabric shade and blackout shade, on the same window.

## Elevate energy efficiency

Roller shades help conserve energy year-round. In the winter, they keep heat from escaping, while in the summer, they help control the heat coming into your facility. They also allow for more natural light further reducing energy use.

From the finest fabrics to uniquely engineered mechanicals and comprehensive design consultation, we have you covered.

## Let us manage your project from start to finish

From design consultation through implementation, our on-staff experts can manage your project every step of the way.

# Roller Shades

## GlacierScreen+ RD 0% Blackout Fabric Specifications

<b>Openness factor:</b>	0% (opaque)
<b>UV blockage:</b>	100% (Approximately)
<b>Composition:</b>	100% polyester with acrylic coating (PVC-free)
<b>Mesh weight:</b>	11.8-oz./yd <sup>2</sup>
<b>Fabric thickness:</b>	0.014"
<b>Fire classification:</b>	NFPA 701-2010 TM#1, California U.S. Title 19

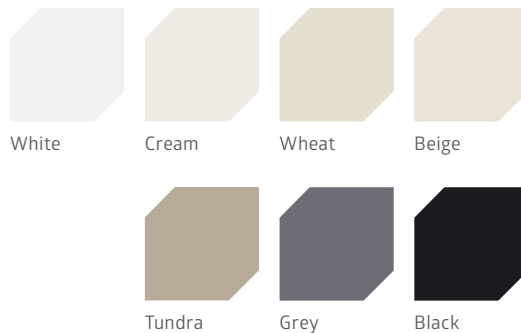

## GlacierScreen+ Basketweave Fabric Specifications

<b>Openness factor:</b>	1%	3%	5%
<b>UV blockage:</b>	99% (Approximately)	97% (Approximately)	95% (Approximately)
<b>Composition:</b>	25% Polyester, 75% PVC		
<b>Mesh weight:</b>	14.7 oz/yd <sup>2</sup>	13.67 oz/yd <sup>2</sup>	12.35 oz/yd <sup>2</sup>
<b>Fabric thickness:</b>	0.028"	0.026"	0.024"
<b>Fire classification:</b>	NFPA 701-2010 TM#1, California U.S. Title 19		



## E Screen 75 Fabric Specifications

<b>Openness factor:</b>	1%	3%	5%
<b>UV blockage:</b>	99%	99%	99%
<b>Composition:</b>	36% fiberglass; 64% vinyl		
<b>Fabric weight:</b>	13.3-oz./yd <sup>2</sup>		
<b>Fabric thickness:</b>	0.020"		
<b>Breaking strength (lbs):</b>	Warp 280/Weft 250 lb		
<b>Fire classification:</b>	NFPA 701-2010 TM#1, California U.S. Title 19		



Colors may vary slightly from swatch samples. All variations are within industry standards.

# Safety and Essentials



# Gloves

## EQPT™ Powder-Free Nitrile Gloves

- Durable, puncture resistant glove with a comfortable and flexible fit
- Black gloves with palm texture for a more secure grip

Item No.	Description	Size	Pkg.
EQPT4195	Nitrile, PF, Black	Medium/Large	100/bx
EQPT4196	Nitrile, PF, Black	Large/X-Large	100/bx



EQPT4195

EQPT4196

## EQPT Cut Level A4 Industrial Gloves

- Cut-resistant gloves for dexterity
- High-performance Gray polyester (HPPE) liner with Gray Sandy microfoam nitrile dip delivers superior protection, grip and breathability
- Durable 13-gauge
- Applications include parts handling, general safety, warehouse, manufacturing, animal handling, metal fabrication, construction, puncture resistance, agriculture, waste management and recycling

Item No.	Description	Size	Pkg.
EQNC4138	Reusable Nitrile Dip Gloves	Medium	1 pr
EQNC41310	Reusable Nitrile Dip Gloves	X-Large	1 pr
EQNC41311	Reusable Nitrile Dip Gloves	XX-Large	1 pr



EQNC4138

## VersaShield Powder-Free Nitrile Exam Gloves

- Powder-free nitrile gloves offer dependable strength and are fully textured for an enhanced grip
- Top of the line chemical protection, tested to ASTM F739-121
- Meets both ASTM D6978-05 and USP 800 Personal Protection Equipment requirement when handling hazardous drugs

Item No.	Size	Pkg.
VS311SH	Small	100/bx
VS311S	Small	100/bx; 1,000/cs
VS311MH	Medium	100/bx
VS311M	Medium	100/bx; 1,000/cs
VS311LH	Large	100/bx
VS311L	Large	100/bx; 1,000/cs
VS311XLH	X-Large	90/bx
VS311XL	X-Large	90/bx; 900/cs



VS311 Series

# Gloves

## FitGuard® Touch Powder-Free Nitrile Exam Gloves

- Great tactile feel with durable nitrile protection
- Textured fingertips for sure grip
- Low and high glove count per box options to help optimize storage
- Color-coded sizing helps quickly identify right size
- Meets USP 800 Personal Protection Equipment requirement for use of chemotherapy gloves when handling hazardous drugs

Item No.	Size	Pkg.
FG100XSH	X-Small	100/bx
FG100XS	X-Small	100/bx; 1,000/cs
FG3000H	X-Small	300/bx
FG3000	X-Small	300/bx; 3,000/cs
FG100SH	Small	100/bx
FG100S	Small	100/bx; 1,000/cs
FG3001H	Small	300/bx
FG3001	Small	300/bx; 3,000/cs
FG100MH	Medium	100/bx
FG100M	Medium	100/bx; 1,000/cs
FG3002H	Medium	300/bx
FG3002	Medium	300/bx; 3,000/cs
FG100LH	Large	100/bx
FG100L	Large	100/bx; 1,000/cs
FG3003H	Large	300/bx
FG3003	Large	300/bx; 3,000/cs
FG100XLH	X-Large	100/bx
FG100XL	X-Large	100/bx; 1,000/cs
FG3004H	X-Large	250/bx
FG3004	X-Large	250/bx; 2,500/cs



FG3000 series

## SensiCare® Silk Powder-Free Nitrile Exam Gloves with SmartBoX® Technology

- Medline's proprietary SmartBoX technology is designed to propel gloves up towards the box opening, reducing PPE waste by 33%\*
- Outstanding tactile sensitivity, stretch, and comfortability
- Textured fingertips for enhanced grip
- Meets both ASTM D6978-05 and USP 800 Personal Protection Equipment requirement for use of chemotherapy gloves when handling hazardous drugs

Item No.	Size	Pkg.
MDSXB7583H	X-Small	250/bx
MDSXB7583	X-Small	250/bx; 2,500/cs
MDSXB7584H	Small	250/bx
MDSXB7584	Small	250/bx; 2,500/cs
MDSXB7585H	Medium	250/bx
MDSXB7585	Medium	250/bx; 2,500/cs
MDSXB7586H	Large	250/bx
MDSXB7586	Large	250/bx; 2,500/cs
MDSXB7587H	X-Large	230/bx
MDSXB7587	X-Large	230/bx; 2,300/cs



MDSXB7585H

\* Data on file.

# Safety Essentials

## Fluid Clean-Up Kits

- For the clean up of spills
- Kit components not made with natural rubber latex

Item No.	Description	Pkg.
MPH17CD410	Deluxe Spill Kit—Quat Contents: Pair Non-Latex Gloves, 1 Protective Gown, 1 Protective Mask With Eye Shield, 10-g Absorbent Powder, 1 Disposable Scoop With Detachable Scraper, 1 Red Bio-Hazard Bag, 2 Twist Ties, 1 Disinfectant Wipe, 1 Hand Wipe, and Instructions For Use; Packaged in a Heat-Sealed Poly Bag.	6/cs
MPH17CE210	Standard Spill Kit—Quat Contents: Pair Non-Latex Gloves, 4-g Absorbent Powder, 1 Disposable Scoop With Detachable Scraper, 1 Red Bio-Hazard Bag, 1 Twist Tie, 1 Disinfectant Wipe, 1 Hand Wipe, and Instructions For Use; Packaged in a Heat-Sealed Poly Bag.	36/cs



MPH17CE210

## Eye/Face Wash Stations

- Durable stations include tamper evident bottles
- Eye wash stations provide quick and easy access to eye wash for emergencies
- Include sterile, irrigating solution for flushing or irrigating the eyes

Item No.	Description	Pkg.
FA024000001	Eye Wash Station, One 16-oz Bottle	6/cs
FA024101001	Eye Wash Refill, 16-oz Bottle	12/cs
FA024102001	Eye Wash Station, Two 16-oz Bottles	6/cs
FA07006	Eye Wash, 4-oz. Bottle, Screw Top	48/cs
FA024300001	Eye Wash Station, Two 32-oz Bottles	6/cs
FA0M7501	15-Min Eye Wash Station	1 ea



FA024000001

## Ear Plug

- Plug gently expands and self adjusts to all size ear canals
- Meets ANSI 53.1974 requirements
- Noise reduction rating (NRR) of 31

Item No.	Description	Pkg.
EVSEARPLUG	Foam, No Cord	200/cs



EVSEARPLUG

## Disposable Bath Mat

- Absorb moisture and resist slipping
- Heavyweight

Item No.	Description	Color	Pkg.
NON24318	13.88" x 21.5" (35.3 x 54.6 cm)	White with Blue Print	500/cs



NON24318

# Other Essentials

## The Clean Remotes

- Universal TV remote
- A spill proof, easy wipe, non-porous surface makes it simple to clean and disinfect
- Hidden battery compartment with attached door so batteries are not taken
- Never has to be reprogrammed, even if batteries are removed
- Patients cannot change menu settings

Item No.	Description	Pkg.
RMICR1H	Universal Remote	1 ea
RMICR1Z	Universal Remote	50/cs
RMICR2BBH	Universal Remote Big Button	1 ea
RMICR3BCBH	Universal Remote Cable Box	1 ea



RMICR1H

## MedCell Alkaline Batteries

- Designed to provide maximum performance in high-tech medical products
- Built to the same specs as the name brand alkaline batteries
- Five-year shelf life

Item No.	Size	Pkg.
MPHBAAA	AAA	144/cs
MPHBAAAZ	AAA	24/cs
MPHBAA	AA	144/cs
MPHBAAZ	AA	24/cs
MPHB9V	9V	72/cs
MPHB9VZ	9V	12/cs
MPHBC	C	72/cs
MPHBCZ	C	12/cs
MPHBD	D	72/cs
MPHBDZ	D	12/cs
MPHBCR2032	Coin Battery	10/bx



MPHB Series



MPHBCR2032

## Economy Workhorse Flashlight

- Sturdy, professional-grade flashlight
- Requires 2 D batteries

Item No.	Size	Pkg.
MPHBECONFL	Economy Flashlight	12/cs



MPHBECONFL

# Reference Guide

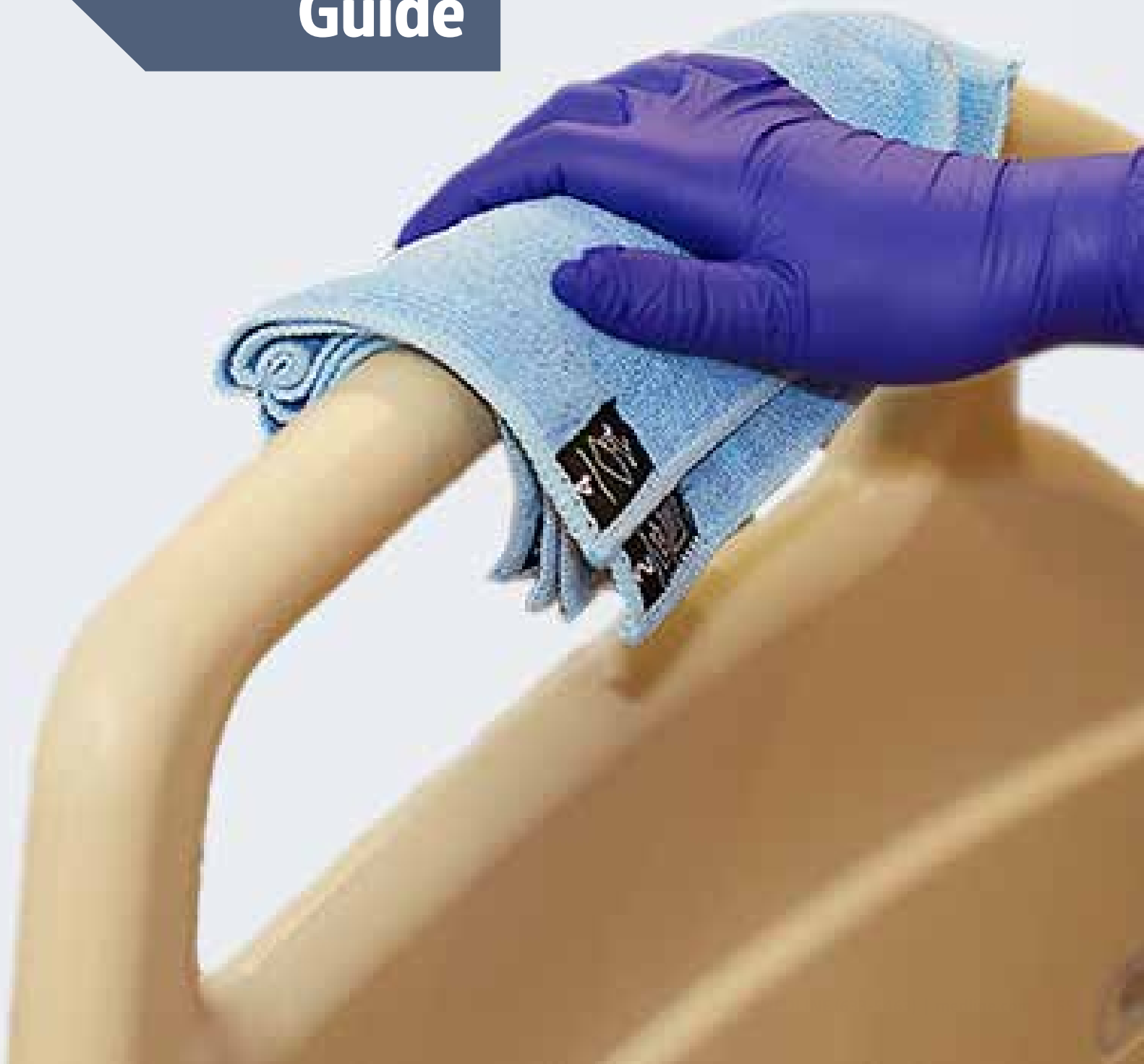

# High-Touch Surfaces

## Disinfect high-touch areas

Avoid cross-contamination by disinfecting with antimicrobial wipes using the numbered order below. It's recommended that you use one wipe for one application per surface to prevent cross-contamination.

\*Please Note: Only use disinfectants on approved surfaces as directed on product label.

### Resident room\*

1. Door knob
2. Light switch
3. Bedside table handles
4. Phone
5. Call button
6. Tray table
- 7a. Left bed rails
- 7b. Right bed rails
- 8a. Chair
- 8b. Chair
9. IV pole
10. Room sink

### Restroom\*

11. Door knob
12. Light switch
13. Restroom sink
14. Handrails
15. Bedpan cleaner
16. Toilet flush handle
17. Toilet seat

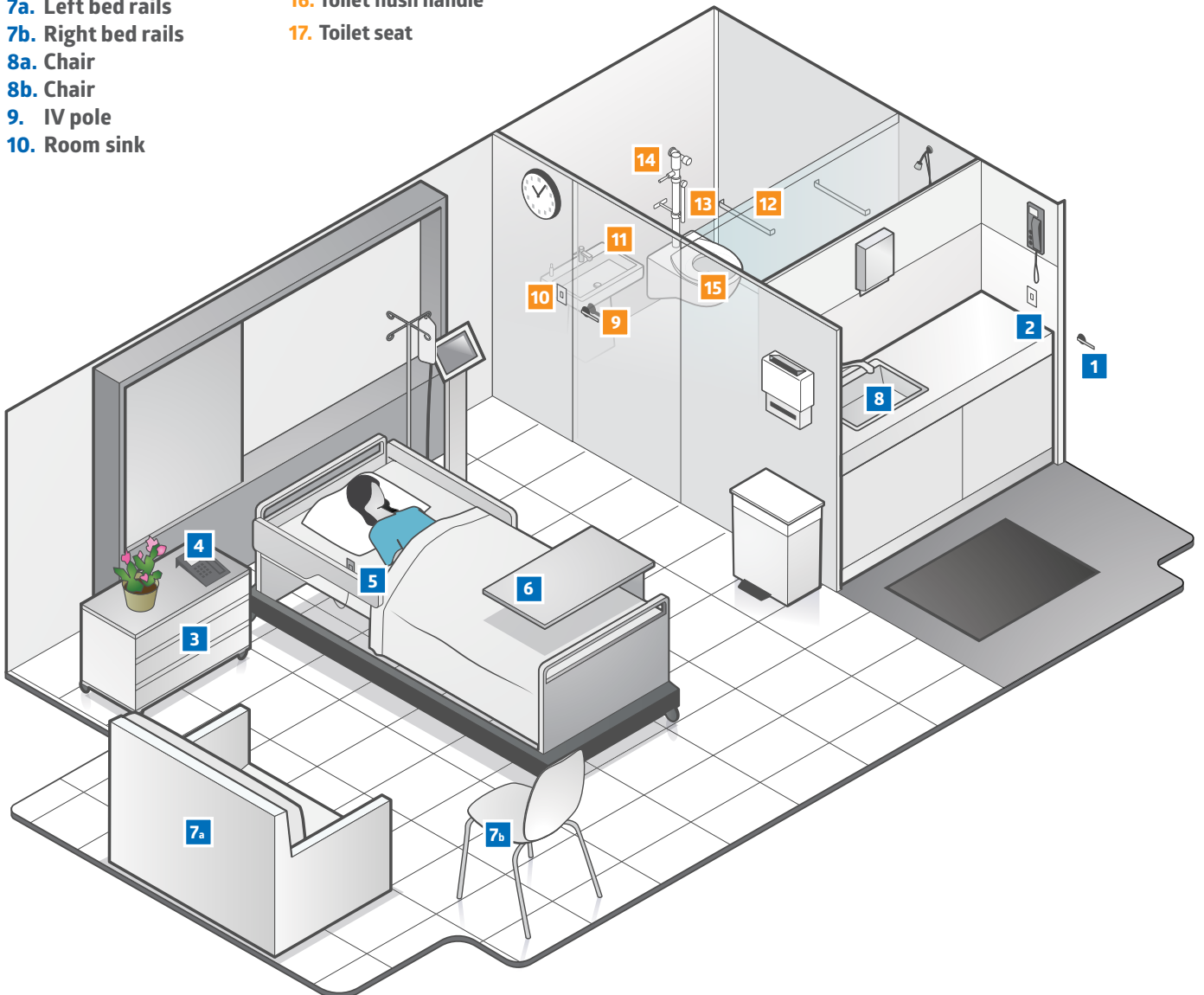

# Cleaning Guide for Patient Rooms

## 1 Prepare to enter the room

- Perform proper hand hygiene.
- Put on protective apparel such as gloves. Before going into isolation rooms, put on additional personal protective equipment.
- Announce your presence before entering the room.



**Product recommended:** CRI4000 (Classic Cover Lightweight Polypropylene Gown)

## 2 Enter the room

- Survey the room for anything that doesn't belong. If you find something, contact the nursing staff about removing it.
- Inspect the privacy curtains. If the room was just used for isolation, or if the curtain is visibly soiled, contact the manager to arrange for cubicle curtain replacement.



**Product recommended:** MIT6DSEREN (Medline Disposable Snap Panel Cubicle Curtain)

## 3 Dispose of waste

- Remove soiled linens.
- Keep hazardous waste separate (i.e., soiled linen, infectious waste, infectious linens).
- Dispose of liners, making sure to close, twist, and tie a knot in the liner while it's still in the trash can. (**NOTE:** Watch out for sharp objects. Never put your hand into the bag or push on it.)



**Product recommended:** NON023143 (Soiled Linen Liner) and other Medline Trash Liners

## 4 Dust the room

- Remove gloves, apply hand hygiene and put on new gloves.
- Start dusting near patient bed and then move outwards (do not dust in occupied ICU/CCU patient rooms).



**Product recommended:** MDT217750 (Microfiber High Duster)

## 5 Wipe high-touch surfaces

- First remove soils and residue with a microfiber cloth or one-step germicide.
- Then apply disposable disinfectant wipes. Use a new wipe for each surface to avoid cross contamination. If a surface starts to dry before the contact time (printed on the disinfectant), apply more product until the correct amount of time has passed.
- For rooms used for isolation, ask the nursing staff if additional cleaning is needed. To kill *Clostridium difficile* (*C. diff.*), a bleach or peracetic acid disinfectant or wipe is needed.
- Only use disinfectants on approved surfaces as directed on product label.

## 6 Begin cleaning the bathroom

- Clean the mirror.
- Disinfect the rest of the bathroom, including: toilet bowl, flushers and seat, sink and countertops, shower, hand rails, and fixtures.
- For tougher stains, use heavy-duty products, such as a more acidic toilet bowl cleaner, foaming acid shower cleaner, or a crème cleanser for soap scum, scale and rust.
- To remove stains and odors from urine, an odor digester/eliminator is recommended.
- Refill soap and lotion dispensers and wipe the outside of these containers.

## 7 Sweep and mop the entire floor

- Work from the furthest corner to the entrance.
- Sweep the floor.
- Mop using a disinfectant or neutral floor cleaner.
- Change the solution every three rooms. For heavier soils, use a general purpose cleaner.

## 8 At the end of the day

- Clean the cleaning tools.
- Remove mop heads and cloths to be washed.
- Wipe down spray bottles.
- Clean the mop and cart handles.
- Dispose of trash in the proper bins.
- Dispose of gloves and wash hands.

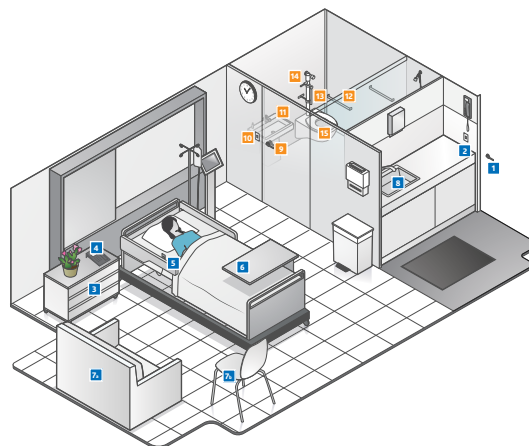

**Products recommended:** MSC351300 (Micro-Kill One Germicidal Alcohol Wipes) and MSC351400A (Micro-Kill Bleach Germicidal Bleach Wipes)



**Products recommended:** EVSCHEM430 (Toilet Bowl Cleaner), EVSCHEM410 (Mild Abrasive Cream Cleanser), EVSCHEM480 (Uric Odor Remover) and EVSCHEM200A (Multi-Surface Glass Cleaner)



**Product recommended:** EVSCHEM210 (Neutral Floor Cleaner) and MICROINSKIT1 (Microfiber Starter Kit)



**Product recommended:** EVSCHEM230 (Multi Surface Peroxide Cleaner)

# Outfit your rooms with everything you need

## Resident room

Medline offers a broad range of products to create comfortable living spaces from environmental service items to resident and staff apparel to linens and curtains.



### Environmental Services

- A** Facial Tissue
- B** Trash Can
- C** Garbage Bags
- D** Cleaning Chemicals
- E** Disinfectant Wipes
- F** Microfiber
- G** Housekeeping Carts
- H** Floor Machine
- I** Air Disinfection Machine

### Curtains/Window Treatments

- A** Cubicle Curtains
- B** Window Treatments

### Apparel

- A** Resident Gowns
- B** Slippers
- C** Adult Bibs
- D** Uniforms (Scrubs/Polos)
- E** Isolation Gowns

### Linens

- A** Fitted Sheet
- B** Flat Sheet
- C** Blanket
- D** Quilt/Bedspread
- E** Pillow/Pillowcase
- F** Underpad

## Resident bathroom



## Environmental Services

- A** Facial Tissue
- B** Toilet Paper
- C** Trash Can
- D** Garbage Bags
- E** Glass Cleaner
- F** Toilet Bowl Cleaner
- G** Toilet Brush with Caddy
- H** Disinfectant Wipes
- I** EVS Equipment
- J** Multifold Dispenser
- K** Paper Towels

## Linens

- A** Washcloths
- B** Bath Towels
- C** Hand Towels

## Curtains/Window Treatments

- A** Shower Curtains
- B** Shower Rod and Hooks

# Checklist for new facility

## Lobby area/foyers

- Scraper mats** (Exterior) Pg. 41–48
- Entrance mats** (Interior) Pg. 48
- Floors** (Finish/recoat) Pg. 96, 103
- Wet floor signs** Pg. 35

## Elevator area

- Trash/recycle cans** Pg. 27–35
- Cleaners for elevator surfaces** Pg. 86–107

## Waiting area

- Garbage bags** Pg. 14–22
- Facial tissues** Pg. 5

## Patient room

- Floors (surfaces)** Pg. 98
- Trash/recycle cans** Pg. 27–35
- Germicidal wipes** Pg. 86–92
- Air fresheners** Pg. 113
- Facial tissues** Pg. 5
- Paper towels/dispensers** Pg. 6–10

## Public restroom

- Tile/grout brush** Pg. 38
- Baseboard cleaners** Pg. 103
- Paper towels/dispensers** Pg. 6–10
- Trash cans** Pg. 27–35
- Garbage bags** Pg. 14–22
- Air freshener** Pg. 113
- Toilet seat covers** Pg. 5

## Nursing unit

- Facial tissue** Pg. 5
- Trash/recycle cans** Pg. 27–35
- Garbage bags** Pg. 14–22
- Eye-wash stations** Pg. 153
- Germicidal wipes** Pg. 86–92
- Blood spill kits** Pg. 153
- Paper towels/dispensers** Pg. 6–10

## Reception area

- Facial tissues** Pg. 5
- Trash/recycle cans** Pg. 27–25

## Patient bathroom

- Trash/recycle cans** Pg. 27–35
- Paper towels/dispensers** Pg. 6–10
- Toilet paper/dispensers** Pg. 6–10
- Toilet seat covers** Pg. 5
- Air fresheners** Pg. 113
- Mirror cleaners** Pg. 97
- Shower cleaners** Pg. 105
- Tile/grout/baseboard cleaners** Pg. 103

## Basement storage area

- Linen carts/cart covers** Pg. 75–79
- Floor scrubbers** Pg. 56
- High-speed floor machines** Pg. 52–63
- Vacuum cleaners** Pg. 56–62

## Janitor's closet

- Chemical dispensers** Pg. 100
- Chemicals** Pg. 86–106
- Ready-to-use products** Pg. 86–106
- 32-gal. large round receptacles** Pg. 28

**Medline MIYO HealthCare  
Housekeeping Workstations**  
Pg. 76



# Ideal cart checklist

## Housekeeping cart

- Healthcare housekeeping cart Pg. 76

## Chemicals

- Bleach Pg. 100

## Wipes

- Dry wipes Pg. 69
- Bleach wipes Pg. 86

## Sweeping

- Squeegee sweeper Pg. 34
- Lobby broom Pg. 33
- Angled broom Pg. 33
- Hand dust pan Pg. 33
- Lobby dust pan Pg. 33
- Threaded wood broom handle Pg. 36

## Toilet bowl

- Disposable toilet seat covers Pg. 5
- Disposable toilet bowl mop Pg. 39
- Cylindrical bowl brush Pg. 39
- Caddy Pg. 39
- Toilet plunger Pg. 39

## Wet floor signs

- Wet floor sign Pg. 35

## Dusting

- High-duster kit/reusable cover Pg. 65
- Disposable high-duster covers Pg. 65
- Lamb's wool duster Pg. 34

## Mopping

- Touchless mop handle Pg. 67
- Adjustable mop handle Pg. 66
- Quick-change mop handle Pg. 36
- Jaw mop handle Pg. 36
- 18" mop frame Pg. 66
- Microfiber screen wringing bucket Pg. 64
- Mop bucket with down wringer Pg. 35
- Mop bucket with side wringer Pg. 35

## Spray bottles

- Bottle and spray trigger Pg. 37
- Empty bottles (32-oz.) Pg. 37
- Trigger sprayer tops Pg. 37

## Putty knife

- Putty knife Pg. 36

## Tile and grout

- Tile and grout brushes Pg. 38

## Hand pads/sponges

- Amazing sponge Pg. 38
- Heavy-duty utility pad Pg. 38
- Medium-duty utility pad Pg. 38
- Medium-duty scrubbing sponge Pg. 38
- Light-duty scrubbing sponge Pg. 38
- Heavy-duty scouring pad Pg. 38
- Medium-duty scouring pad Pg. 38

# Empower your EVS Staff

Discover tools and training that can make a positive impact at your facility



**We make  
healthcare  
run better™**

Medline Industries, LP | 1-800-MEDLINE (633-5463) | [www.medline.com](http://www.medline.com)

©2025 Medline Industries, LP. All rights reserved. Medline is a registered trademark of Medline Industries, LP. All product names, regardless of whether or not they appear with a trademark symbol, are the property of their respective companies unless otherwise noted.  
MKT19W6599134 / LIT740R / 2.5M / PP / 89

Some products may not be available for sale in Mexico or Canada. We reserve the right to correct any errors that may occur within this brochure.