



**TAKE CARE OF  
YOUR CAREGIVERS.**

**Solutions for Safe Patient Handling**  
Reduce injury risks and associated costs

# Workplace injuries come at high cost.

**\$20 BILLION**

Estimated costs to the healthcare industry associated with back injuries<sup>1</sup>

---

**50%**

Caregiver injuries that are musculoskeletal<sup>2</sup>

---

**2x INJURIES**

Hospital workers compared to the national average<sup>3</sup>

---

**56%**

Nurses who leave the profession early due to the physical demands<sup>4</sup>

---

**20%**

Nurses who transfer to a different unit, position, or employment because of lower back pain<sup>5</sup>

---

**25%**

Healthcare industry workers' compensation claims from patient-handling injuries<sup>6</sup>

---

**\$27,000 – \$103,000**

Costs of replacing one nurse, factoring in separation, recruiting, hiring, productivity loss, orientation and training<sup>7</sup>

---

**\$15,600**

The average cost of one workers' compensation claim related to patient handling<sup>8</sup>

---

**UP TO  
\$70,000**

Fines for non-compliance with OSHA requirements<sup>9</sup>

---

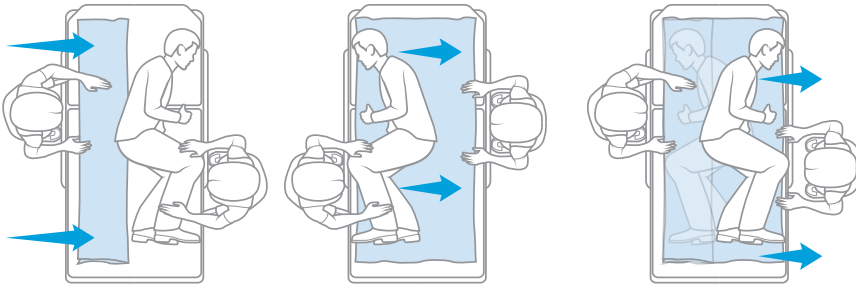

# How do you help prevent workplace injuries and keep caregivers safe?

Many caregivers put patient needs before their own and believe getting hurt is just part of the job. Changing this culture isn't easy. We can help with our all-inclusive safe patient handling program and innovative products.

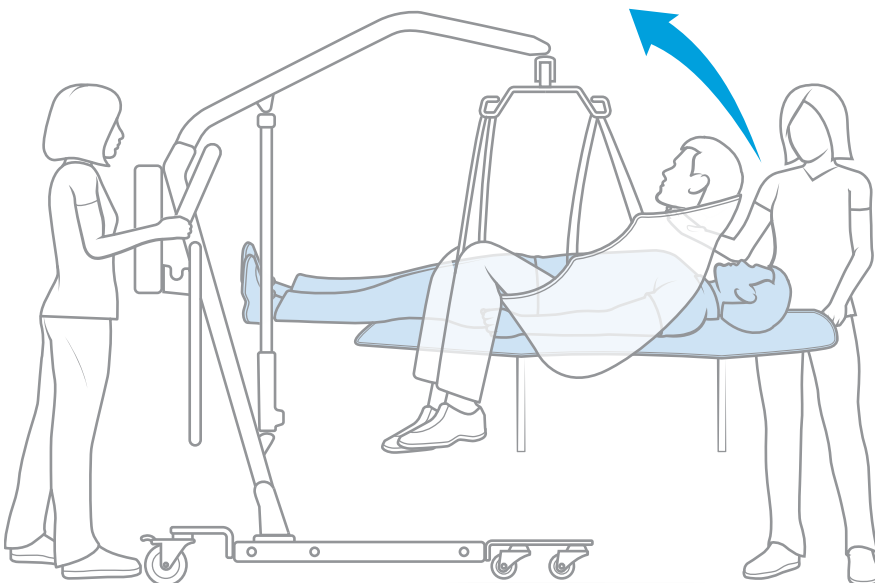
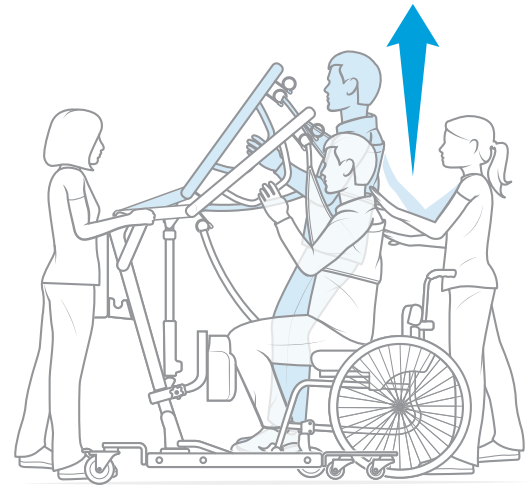

Safe Patient Handling Program	4
Safe Patient Handling Assessment	6
Repositioning System	7
Lifts	11
Slings	18



Put best practices to good use.

## Safe Patient Handling Program

Prevent staff injuries and avoid high costs of OSHA fines and workers comp claims with our Safe Patient Handling Program.

Plus, you'll improve patient care. Safe patient handling programs have been shown to greatly reduce everything from falls to pressure ulcers.<sup>9</sup> And a lift feels much more comfortable and secure than the arms of a nurse, increasing patient dignity and satisfaction.

### Our Safe Patient Handling Program includes:

- » **Policies and procedures.** Implement best practices established by OSHA.
- » **Assessments.** Take advantage of regular assessments, before and after implementation, and annually.
- » **Staff training.** Make sure your staff uses your equipment properly, with picture guides, movement instructions, in-service videos and more.

FREE

with the purchase of a lift

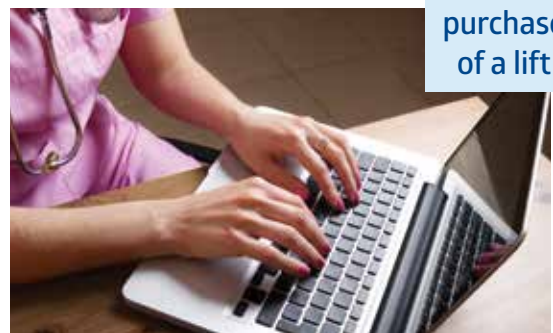

# Know you're inspection ready.

Our Safe Patient Handling Program helps you prepare for every question compliance officers ask.

The Occupational Safety and Health Administration (OSHA) has announced new safe patient handling requirements for facilities in every state to avoid fines up to \$70,000.<sup>9</sup>

## Actual Evaluation Questions

Asked during OSHA evaluations

## Where to Find Answers

Components of our Safe Patient Handling Program

### PROGRAM MANAGEMENT

Is there a system for identifying and analyzing hazards?

» Pre-Implementation Assessment

Is there a system for developing strategies to address those hazards?

Who has the responsibility and authority for administering this system?

» Program Guidelines

What are the credentials or experience of the individual responsible for administering the program?

What input have employees provided in the development of the establishment's lifting, transferring, or repositioning procedures?

» Program Guidelines Tool  
» Annual Assessment

Is there a system for monitoring compliance with the establishment's policies and procedures and following up on deficiencies?

» Annual Assessment

Are there records of recent changes in policies/procedures and an evaluation of the effect they have had on resident handling injuries and illnesses?

» Program Guidelines Tool  
» Pre and Post Assessments

### PROGRAM IMPLEMENTATION

How is patient mobility determined and how is the mobility determination communicated to staff?

» Safe Patient Handling and Movement Instructions

What is the decision logic for selection and use of lift, transfer, or repositioning devices?

When and under what circumstances may manual lift, transfer or repositioning occur?

Who decides how to lift, transfer, or reposition patients/residents?

» Laminated Instruction Guides  
» In-Service Videos  
» Movement Instructions  
» Lifting Competencies  
» Medline University CE Safe Patient Handling Courses

Is there an adequate quantity and variety of appropriate lift, transfer or reposition assistive devices available and operational?

Are there adequate numbers of supplies such as: slings, batteries, and charging stations for lifting devices?

Are there appropriate quantities and types of the assistive devices available within close proximity and maintained in a usable and sanitary condition?

» Pre-Implementation Assessment  
» Annual Assessment

### EMPLOYEE TRAINING

Have employees been trained in the recognition of ergonomic hazards associated with manual patient lifting, transferring, or repositioning, the early reporting of injuries, and the establishment's process for abating those hazards?

Have the employees been trained in proper techniques and procedures to avoid exposure to ergonomic risk factors and can they demonstrate competency in performing the lift, transfer, or repositioning task using the assistive device?

» Laminated Instruction Guides  
» In-Service Videos  
» Medline University Safe Patient Handling CE Courses  
» Lifting Competencies  
» Quizzes



Find out  
where  
you stand.

FREE

no obligation  
assessment

## Safe Patient Handling Assessment

Knowing if you're 100% compliant with the most recent OSHA guidelines can be challenging. We can help.

With our Safe Patient Handling Assessment, you'll know exactly where you stand and what you need to do to meet requirements. All with minimal disruption, no paperwork and **no cost to you**.

We'll summarize your current patient population—bariatric, partially or non-weight bearing, dependent or independent, etc.—and the condition of all your Safe Patient Handling equipment.

### How it works

For each floor or unit, your Medline Representative reviews your protocols and training for—

- ✓ Hazard identification and removal
- ✓ Injury reporting
- ✓ Patient repositioning and transfers
- ✓ Patient mobility determination
- ✓ Equipment selection and use

You'll receive a concise report with our findings and recommendations—it's the hard data you need for making informed decisions.

# One good turn deserves another.

## The Comfort Glide® Solution

Comfort Glide repositioning products work together to ease the stress of turning on both caregivers and patients.

- » Repositioning Sheets
- » Fitted Sheets
- » Wedges
- » Drypads



Comfort Glide  
Repositioning Sling  
MDSC40018



30-Degree Comfort Glide Foam Wedges  
MSC50024, MSC50023



X-Large Comfort Glide Drypad  
CGLIDEPADXL



Standard Comfort Glide  
Repositioning Sheet  
CGLIDESHEETNS

## Comfort Glide Repositioning Sheets, Single-Patient Use

Comfort Glide Repositioning sheets are designed and tested to help reduce the exertion needed to turn patients.

- » Low-friction nylon bottom surface requires 35% less effort than a draw sheet
- » Multiple handles help optimize weight distribution and leverage
- » Air-permeable for remaining under patients, always available
- » Soft, breathable microfiber top surface, compatible with low air-loss mattresses
- » Optional retention straps anchor the sheet to the bed
- » Safety rated for up to 575 pounds; bariatric sheet rated to 1,000-lb.



Item No.	Description	Pkg.
CGLIDESHEET	Glide Sheet 35" x 55", with Straps	12/cs
CGLIDESHEETNS	Glide Sheet 35" x 55"	12/cs
CGSHEETXLD	Glide Sheet, X-Large, 42" x 78", Two Optional Straps	12/cs

## Comfort Glide Repositioning Sheet and Sling in One (See p. 20)



Item No.	Description	Pkg.
MDSC40018	Patent-Pending 2-in-1 Sling and Repositioning Sheet, Disposable, 1,000-lb. Weight Capacity, 42" x 78"	12/cs

Two Products In One

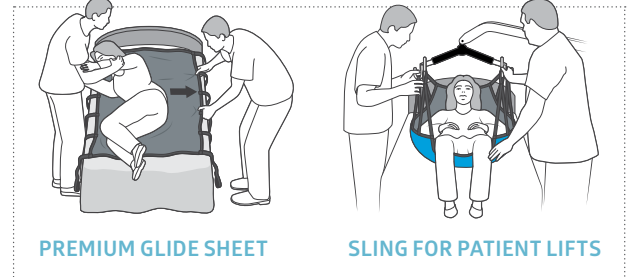

## The evidence base

### Average Force Required to Initiate Slide

This graph shows the force required to initiate sliding a 200-pound object across a hospital bed. The lower the number, the easier it is for healthcare workers to initiate sliding a patient.<sup>11</sup>

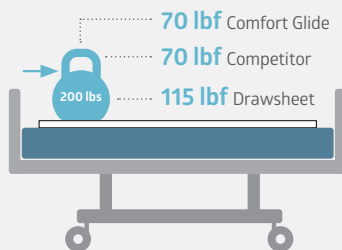

lbf = pounds of force.

### WVTR Test for Breathability

Water Vapor Transmission Rate (WVTR in units g/(m<sup>2</sup>\*day)) measures the amount of water vapor that passes through a material. The higher the number, the more breathable the material. The Comfort Glide sheet performed as well as the leading competitor.<sup>12</sup>



g = grams, m<sup>2</sup> = square meters, day = days

### Comfort Glide Air

Inflatable repositioning and transfer sheet gives caregivers a safe and physically easy way to move patients.

- » Cushion of air to help transfer and reposition patients without lifting
- » Easy-access handles reduce muscle strain
- » Wider size helps optimize leverage
- » Air-permeable so it can remain under patients to aid repositioning
- » Requires 65% less effort than a standard draw sheet to move a patient<sup>11</sup>
- » Safety rated for patients up to 625 pounds



MSC60011

Item No.	Description	Pkg.
MSC60011	Comfort Glide Air Inflatable Sheet	12/cs

### Comfort Glide Foam Wedges

High-density foam helps keep patients in the recommended 30-degree tilt position, reducing pressure on bony prominences.

- » Non-slip base grips the surface of any mattress or linen
- » “Down” arrows ensure proper placement
- » Soft, composite fabric covering can be wiped clean
- » Holds patients in a 30-degree tilt position
- » Non-slip bottom grips the surface of any mattress or linen
- » High-density foam doesn't flatten out



Item No.	Description	Pkg.
MSC50023	30-Degree Foam Wedges, Non-Slip Base: 11" x 5" x 16"	2/pk, 6 pk/cs
MSC50024	30-Degree Foam Wedges, Non-Slip Base: 15" x 6.5" x 16"	2/pk, 2pk/cs

### Comfort Glide Fitted Sheets

Low-friction, breathable polyester fabric to help reduce the effort to slide a patient.

- » Contoured elastic perimeter hugs the mattress for a close fit without awkward buckles
- » Compatible with low air-loss mattresses
- » Can be laundered up to 50 times
- » Available in four different sizes to fit a wide range of mattresses



CGLIDEBASE36

Item No.	Description	Pkg.
CGLIDEBASE36	Fitted Base Sheet, 36 x 80", Blue	12/cs
CGLIDEBASE42	Fitted Base Sheet, 42 x 80", Purple	12/cs
CGLIDEBASE50	Fitted Base Sheet, 50 x 80", Black	12/cs
CGLIDEBASE54	Fitted Base Sheet, 54 x 80", Black	12/cs

### Comfort Glide Drypads, Single-Patient Use, Disposable

These Ultrasorb level drypads are designed to manage moisture over an extended period of time and keep patients 26 times drier than the leading competitor.<sup>14</sup>

- » Draws in moisture, locks it away from skin and feels dry to the touch within minutes
- » Air-permeable for optimal patient comfort and zero strikethrough
- » Compatible with low air-loss mattresses
- » Sizes designed to completely cover the repositioning sheets

57" Standard Length

80" X-Large Length

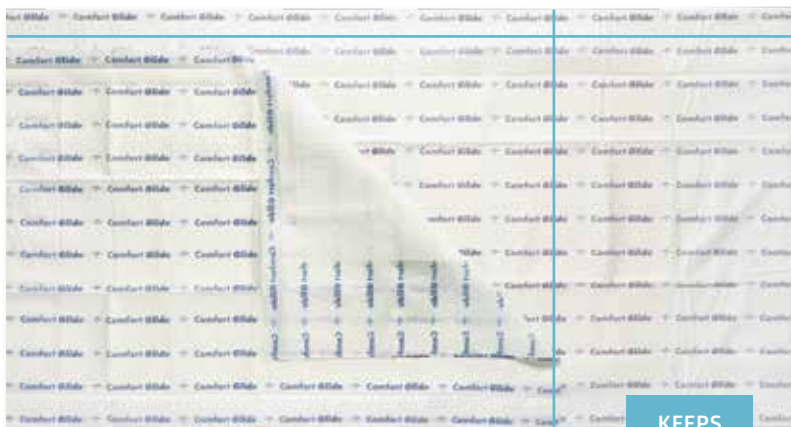

Item No.	Description	Pkg.
CGLIDEPAD	Drypads, 36" x 57"	5/bg, 60/cs
CGLIDEPADXL	X-Large Drypads, 40" x 80"	5/bg, 40/cs

KEEPS PATIENTS  
**26**  
TIMES  
DRIER

than the leading competitor

### Drypad Performance

A drypad's ability to withstand multiple incontinence episodes is determined using the "rewet" test. The test is done by pouring 100 milliliters of water onto a drypad, waiting 60 seconds and then measuring how much water returns to the surface. The lower the number, the drier it is against patient skin.<sup>13</sup>

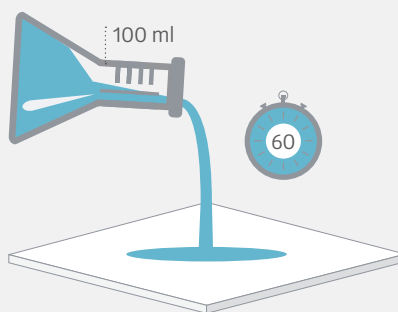

0.08 g  
Comfort  
Glide



2.08 g  
Leading  
Competitor



### Tubular Slide Sheets, Disposable

Make lateral transfers and patient repositioning easier.

- » Wide size accommodates more patients
- » Single-use only

Item No.	Description	Pkg.
MDSSLIDE5848	Slide Sheet, Tube, 58" x 48"	50/cs
MDSSLIDEWALL	Optional Wall Holder	ea



MDSSLIDE5848



MDSSLIDEWALL

# Elevate patient and caregiver safety

The Association of Safe Patient Handling Professionals (ASPHP) recommends one mobile lift for every eight patients who need one. Our lifts can help you reduce risks of caregiver injuries and lift patients with exceptional safety, convenience and dependability.

## Training program for proper lifting

Make sure your staff knows the best practices for proper patient handling and moving. Ask your Medline Representative about our training program for patient lifts.

## Service plans for extra confidence

Keep patients and caregivers safe while protecting your facility from costly last-minute repairs with your choice of two service plans:

- » **Preventive Maintenance Plan**—full inspection and lubrication of moving parts to ensure proper lift operation
- » **Full-Service Plan**—all the advantages of the Preventive Maintenance Plan, plus unlimited troubleshooting and repair hours—ideal for equipment that's past warranty



MDS450EL

# Overhead lift system

This system makes it simple to own and install overhead lifts in almost any facility.

- » Single-motor has a weight capacity of up to 600 lbs., or two motors can be combined with reinforced track to handle up to 1,000 lbs.
- » Auto-locking cradle design guarantees that slings stay secured to the cradle during lifting
- » Track lengths may be trimmed to any room size that is 7 meters or less
- » Industry-leading 3-year warranty on the lift motor



ERGLUNA



ERGHANDCTRL



ERGSREADER



ERGETRK43

## Motor Components

Item No.	Description	Pkg.
ERGLUNA	600-lb. Capacity Overhead Lift Motor	ea
ERGHANDCTRL	Hand Control Pendant for Overhead Lift	ea
ERGSREADER	Spreader Bar for Overhead Lift	ea
ERGCHARGER	Charging Station for Overhead Lift	ea

## E-Track Rail Components

Item No.	Description	Pkg.
ERGETRK43	4.3M Length E-track for Overhead Lift	ea
ERGETRK55	5.5M Length E-track for Overhead Lift	ea
ERGETRK7	7M Length E-track for Overhead Lift	ea
ERGETRKENCV	End Cover for E-track	pr
ERGETRKCVPL	Cover Plate for E-track	ea
ERGETRKENST	End Cover for E-track	ea

## Traverse Rail Components

Item No.	Description	Pkg.
ERGVTRK43	4.3M Length Traverse Rail for Overhead Lift	ea
ERGVTRK55	5.5M Length Traverse Rail for Overhead Lift	ea
ERGVTRK7	7M Length Traverse Rail for Overhead Lift	ea
ERGVTRK43R	Reinforced 4.3M Length Traverse Rail for Overhead Lift	ea
ERGVTRK55R	Reinforced 5.5M Length Traverse Rail for Overhead Lift	ea
ERGVTRK7R	Reinforced 7M Length Traverse Rail for Overhead Lift	ea
ERGVTRKENST	End stop for Traverse Rail	ea

## Cart Accessories

Item No.	Description	Pkg.
ERGARTBY	Bayonet Cart for Motor	ea
ERGARTTN	Turning Bracket Cart for Motor	ea
ERGARTXYFX	Fixed XY Cart	ea
ERGARTXYAJ	Adjustable XY Cart	ea
ERGARTXYFXD	Drop-down Fixed XY Cart	ea
ERGARTXYAJD	Drop-down Adjustable XY Cart	ea

# Mobile lifts

Emergency release provides for smooth lowering in case the battery dies unexpectedly.

- » State-of-the-art control panel displays battery charge level and more
- » Removable battery pack reduces downtime with off-board charging
- » Can be lowered to floor height for lifting a patient who has fallen
- » Compatible with lift scales for convenient weighing of patients
- » Warranty: three years on all mechanical and electrical parts, one year on the battery

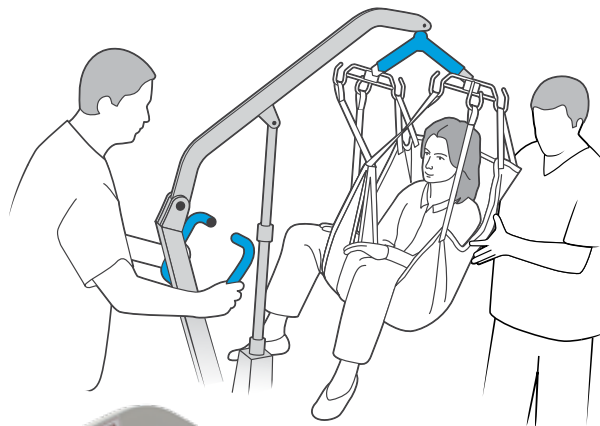

MDS450EL  
(Shown with optional gait training arms)

Item No.	Description	Pkg.
MDS400EL	400-lb. Capacity Lift w/Manual Base	ea
MDS450EL	450-lb. Capacity Lift w/Powered Base	ea
MDS500EL	500-lb. Capacity Lift w/Manual Base	ea
MDS600EL	600-lb. Capacity Lift w/Manual Base	ea
MDS700EL	700-lb. Capacity Lift w/Powered Base	ea
MDSMELSCALE	700-lb Capacity Scale Accessory for Mobile Lift	ea

**FREE**

Comprehensive Safe Patient Handling Program, **FREE** with your purchase of a lift. See pgs. 4–5 for details.

## Manual Patient Lift Cradle

Enables caregivers to position patients with one hand, providing better control and helping prevent injuries.

- » Helps to eliminate grabbing and pulling
- » Improves patient confidence
- » Makes the caregiver's job easier
- » Compatible with Medline mobile lifts MDS450EL and MDS700EL



MDS700MCRD

Item No.	Description	Pkg.
MDS700MCRD	Patient Lift Cradle (Use with Clip Slings)	ea

## Stand assist lifts

Help patients stand or practice bearing weight during rehab.

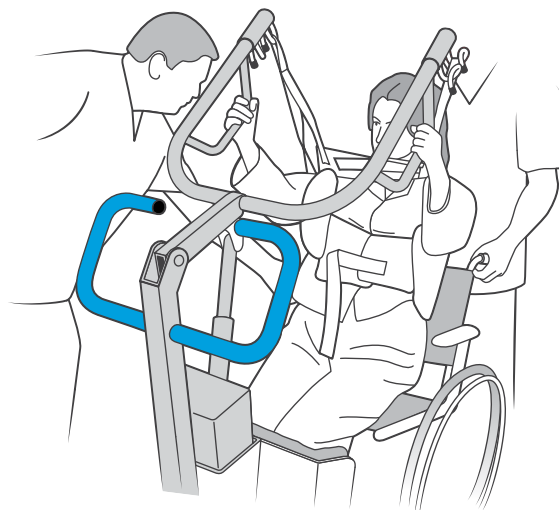

One stand assist lift is recommended for every eight patients that need one

1:8

- » Removable foot platform for gait training
- » Adjustable knee pad for finding the perfect fit for anyone
- » State-of-the-art control panel displays battery charge level and more
- » Removable battery pack reduces downtime with off-board charging
- » Warranty: three years on all mechanical and electrical parts, one year on the battery

Item No.	Description	Pkg.
MDS400SA	400-lb. Capacity Stand Assist w/Manual Base	ea
MDS500SA	500-lb. Capacity Stand Assist w/Powered Base	ea
MDS600SA	600-lb. Capacity Stand Assist Lift w/Manual Base	ea



MDS500SA

# Lifting shower chair

Make bathroom tasks easier, more efficient and safer for the caregiver.



Use with a bedpan or over a toilet



Easily tilt backward for feet access



Adjust height and tilt with simple controls

Our new lifting shower chair is designed with OSHA requirements in mind to help you reduce staff risks. Plus, working at the optimal height makes bathing tasks easier, faster and more efficient.

- » Smooth, energy efficient electric height and tilt adjustments
- » Intuitive, easy-to-use control console
- » Multifunctional for showering and toileting
- » Comfortable foam padding and adjustable headrest
- » Arms lock down for safety or fold away for easier transfers

Item No.	Description	Pkg.
MDSREFLEX	300-lb. Capacity Shower Chair Lift	ea

**FREE**

Comprehensive Safe Patient Handling Program, **FREE** with your purchase of a lift. **See pgs. 4-5 for details.**



MDSREFLEX

# Raizer® Mobile Lifting Chair

Now there's a better way to lift someone after a fall.

This sleek, innovative, battery-operated chair **enables one assistant to safely raise a large adult** to a sitting or standing position in just a few minutes.

- » **Easy to carry**—Two handy bags hold seven lightweight components
- » **Simple setup**—Color-coding guides the placement of components, and a loud click confirms each connection
- » **Gentle on caregiver backs**—Requires virtually no physical effort besides a supportive hand
- » **Fast**—In minutes, one assistant can set up and raise a large adult from the floor to a standing position
- » **Easy to clean**—Cleaning's a snap with the smooth surfaces on all Raizer components

Item No.	Description	Pkg.
MDSRAIZER	Raizer Mobile Lifting Chair	ea



**Mechanically lift** using the console buttons or remote control

**Powerful rechargeable battery** provides up to 40 lifts on one charge



Patients are **lifted safely and comfortably** from the floor in minutes

**Small footprint fits in tight spaces**

Add this innovative chair to your safe patient handling program and prevent patient and staff injuries.

All in 4 easy steps:



- 1** Place the seat motor under the person's knees



- 2** Attach components to the seat motor



- 3** Mechanically lift the patient using the console buttons or remote control



- 4** Transfer the patient to a walker or wheelchair



Color-coding makes setup simple

### Technical Specifications

Weight Capacity	330-lb.
Lifting Time	20–30 secs.
Product Weight:	28-lb. total
Charger	Two pieces: Soniel 12v, 100-240v 12v car adapter
Number of lifts on a full charge	40 at maximum weight capacity
Charging Time	6 hours



Two handy carrying bags hold seven lightweight components.

# Choose the right slings in the right fabric.

Your lifting equipment helps prevent injuries for both patients and caregivers. However, not all slings are created equal.

Our product portfolio includes eight innovative fabric choices with comfort-enhancing details to meet every patient need.



## At-a-glance sling selection

Decide which sling style is most appropriate for your intended use.

	Bathing and Toileting	Transferring	Repositioning
Polyester Mesh (pg. 24)	✓		
Toileting (pg. 29)	✓		
U-shaped (pg. 23-24, 26-27, 30-32)	✓	✓	
Stand-assist (pg. 21, 28, 30)	✓	✓	
Knitted fabric (pg. 26-28)		✓	
Spacer fabric (pg. 22-23)		✓	
Single-patient use (pg. 30-31, 33)		✓	
ComfortRise™ Sling (pg. 22)		✓	✓
Comfort Glide® Sling (pg. 20)		✓	✓
Repositioning (pg. 22-23, 33)			✓

### Sizing tool

- 1 Choose your preferred sling style.
- 2 Weigh the patient to determine the needed capacity.
- 3 Measure the patient for a proper fit using the chart below.

#### General Transfer Slings

Measure the patient's shoulder circumference (A):

Small	Medium	Large	X-Large
28"-45" (71-114 cm)	37"-57" (94-145 cm)	47"-67" (119-170 cm)	57"-80" (145-203 cm)

#### Toileting Slings

Measure the patient's chest circumference (B):

Small	Medium	Large	X-Large
26"-42" (66-107 cm)	30"-48" (76-122 cm)	38"-60" (97-152 cm)	58"-73" (147-185 cm)

#### Stand-Assist Slings

Measure the patient's chest circumference (B):

Small	Medium	Large	X-Large
28"-42" (71-107 cm)	30"-48" (76-122 cm)	36"-60" (91-152 cm)	50"-79" (127-201 cm)

*Sizing tool is a guideline only.*

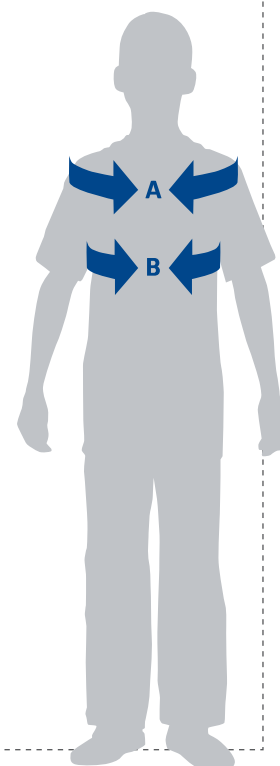

# Hybrid microfiber nylon

Soft, breathable microfiber top, smooth nylon bottom.

## Comfort Glide® Sling and Repositioning Sheet in One

### *Microfiber/Nylon*

A revolutionary, patent-pending innovation. All-in-one glide sheet and sling helps improve safety, efficiency and patient care. The skin-friendly, breathable material can remain in bed with the patient throughout their length of stay (single-patient use).

**Glide sheet**—the smooth underside minimizes friction for easy sliding, and the handles along the perimeter enable repositioning by multiple caregivers. Proven Comfort Glide Sheet technology is compatible with our Comfort Glide wedges and UltraSorbs® drypads.

**Sling**—the twelve strong straps offer attachment options to maximize patient comfort and safety.

- » Reduce staff lifting tasks during transfers
- » Save staff time with fewer steps to use a lift
- » Eliminate SKUs with multi-use products
- » Have more time to spend with patients

#### RECOMMENDED USE

Repositioning tasks and patient transfers.

Item No.	Style	Dimensions	Wt. Cap.	Pkg.
MDSC40018	Flat, Over Mattress	42" x 78"	1,000-lb.	12/cs

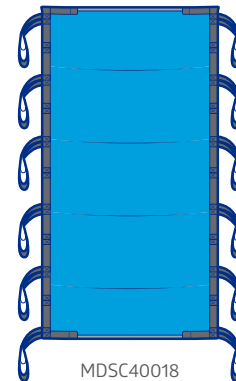

MDSC40018

USE WITH  
**6-PT.**  
CRADLES

# Textured grip fabric

Strong and flexible, soft to the touch, neoprene adds advanced functionality to a standard sling.



## Grip Sling for Stand-Assist Lifts

*Neoprene*

The Grip Sling adheres to clothing and is less likely to slide up under the arms and create pressure during a stand-assist transfer.

- » Uniquely comfortable for patient satisfaction
- » Specially textured neoprene material
- » Soft padding in the underarm and lumbar areas



MDSGRIPSLING3

USE WITH  
STAND  
ASSIST  
LIFTS

### RECOMMENDED USE

Patient toileting and transfers with stand-assist lifts for extra support for standing.

Item No.	Size	Dimensions	Wt. Cap.	Pkg.
MDSGRIPSLING2	Medium	30" x 48"	500-lb.	ea
MDSGRIPSLING3	Large	36" x 60"	500-lb.	ea

## Spacer fabric

Warp-knitted polyester “spacer” fabric.

- » **Redistributes pressure.** Studies show that the spacer fabric improves surface-area contact.<sup>15</sup>
- » **Breathable.** Air and moisture permeable, and compatible with low air-loss mattresses.
- » **Reduces shear.** The fabric stretches in all directions to help reduce shear.
- » **Comfortable.** Studies show that patients prefer the soft feel over traditional sling fabrics, polyester and slipfit.<sup>15</sup>

### ComfortRise™ Repositioning Sheet and Sling in One

#### Spacer Fabric

Dual functionality reduces patient disruptions, opportunities for staff back injuries and SKUs for facilities to purchase, store and put into service.

- » Smooth nylon underside glides easily over beds
- » Twelve straps for redistributing weight by multiple caregivers
- » Eliminates a glide sheet purchase and costs similar to a sling

#### RECOMMENDED USE

Repositioning and routine lifting, especially for patients with pressure ulcers or limited upper-body function and tone.

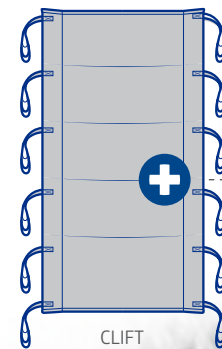

USE WITH  
6-PT.  
CRADLES

Item No.	Style	Dimensions	Wt. Cap.	Pkg.
CLIFT	Flat, Over Mattress	42" x 78"	700-lb.	ea

## U-Shaped Sling

Spacer Fabric

### RECOMMENDED USE

Toileting and routine lifting, especially for patients with pressure ulcers or limited upper-body function and tone.

Item No.	Size	Dimensions	Wt. Cap.	Pkg.
MDSPUNVS	Small	33.5" x 41"	450-lb.	ea
MDSPUNVM	Medium	40" x 48"	450-lb.	ea
MDSPUNVL	Large	44" x 53"	450-lb.	ea
MDSPUNVXL	X-Large	47" x 60"	450-lb.	ea

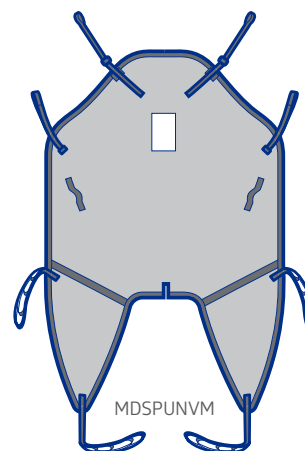

USE WITH  
6" PT.  
CRADLES

## Hammock Sling

Spacer Fabric

### RECOMMENDED USE

Toileting and routine lifting, especially for patients with pressure ulcers or limited upper-body function and tone.

Item No.	Size	Dimensions	Wt. Cap.	Pkg.
MDSPHAMS	Small	33.5" x 37.5"	450-lb.	ea
MDSPHAMM	Medium	38" x 42"	450-lb.	ea
MDSPHAML	Large	41" x 43"	450-lb.	ea
MDSPHAMXL	X-Large	46.5" x 46.5"	450-lb.	ea

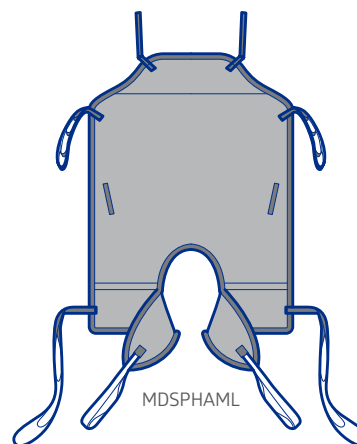

USE WITH  
6" PT.  
CRADLES

## Repositioning Sling

Spacer Fabric

### RECOMMENDED USE

Turning or repositioning patients in bed, especially for those with pressure ulcers.

Item No.	Style	Dimensions	Wt. Cap.	Pkg.
MDSPPPOS	Flat	42" x 78"	440-lb.	ea
MDSPPPOSE	Fitted, with Elastic	42" x 78"	440-lb.	ea

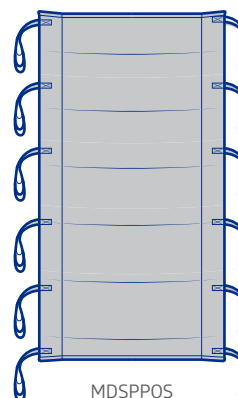

USE WITH  
6" PT.  
CRADLES

# Polyester mesh

Our polyester mesh is ultra-strong and soft to the touch. The synthetic material retains its brilliant color, wash after wash. Skillful workmanship and reinforced stitching support high weight capacities.

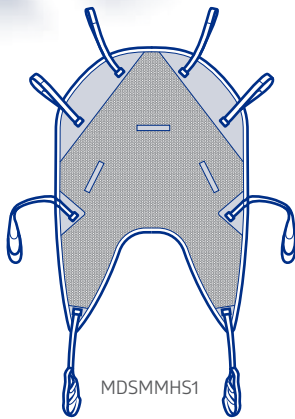

## U-Shaped Sling

*Polyester Mesh Fabric*

### RECOMMENDED USE

Patient bathing and toileting.

### With Head Support

Item No.	Size	Dimensions	Wt. Cap.	Pkg.
MDSMMHS1	Small	33" x 49"	450-lb.	ea
MDSMMHS2	Medium	38.5" x 54"	450-lb.	ea
MDSMMHS3	Large	42.5" x 59"	450-lb.	ea

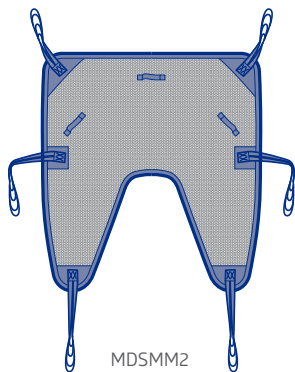

### Without Head Support

Item No.	Size	Dimensions	Wt. Cap.	Pkg.
MDSMM2	Medium	39" x 47"	450-lb.	ea
MDSMM3	Large	43" x 48"	450-lb.	ea

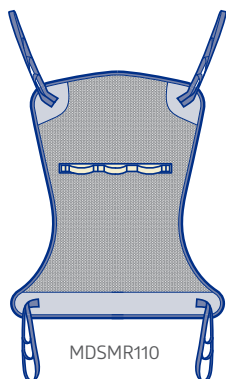

MDSMR110

USE WITH  
4-PT.  
AND  
6-PT.  
CRADLES

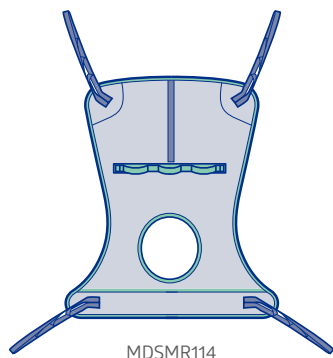

MDSMR114

USE WITH  
4-PT.  
AND  
6-PT.  
CRADLES

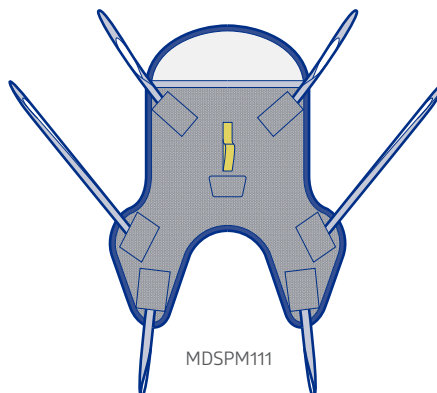

MDSPM111

USE WITH  
4-PT.  
AND  
6-PT.  
CRADLES

### Full-Body Sling

*Polyester Mesh Fabric*

#### RECOMMENDED USE

Routine lifting, especially for amputee patients.

#### Without Commode Opening

Item No.	Size	Dimensions	Wt. Cap.	Pkg.
MDSMR110	Medium	30" x 47"	450-lb.	ea
MDSMR111	Large	34" x 52"	450-lb.	ea
MDSMR140	XX-Large	42" x 52"	700-lb.	ea

#### With Commode Opening

Item No.	Size	Dimensions	Wt. Cap.	Pkg.
MDSMR114	Medium	32" x 48"	450-lb.	ea
MDSMR115	Large	35" x 50"	450-lb.	ea
MDSMR116	X-Large	37" x 56"	450-lb.	ea
MDSMR141	XX-Large	42" x 50"	700-lb.	ea

### Pediatric Sling

*Polyester Mesh Fabric*

#### RECOMMENDED USE

Bathing and toileting of pediatric patients over 35-lb. (16 kg).

Item No.	Size	Dimensions	Wt. Cap.	Pkg.
MDSPM111	One Size Fits Most	21" x 33"	100-lb.	ea

## Knitted fabric

This fabric has just the right amount of “give” for a secure, comfortable and easy fit. But don’t let it fool you. This heavy-duty choice is designed to withstand high weight capacities and rigorous healthcare use.

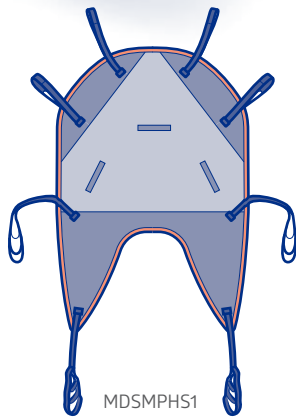

USE WITH  
6-PT.  
CRADLES

### U-Shaped Padded Sling

*Knitted Fabric*

#### RECOMMENDED USE

Patient transfers.

#### With Head Support

Item No.	Size	Dimensions	Wt. Cap.	Pkg.
MDSMPHS1	Small	31.5" x 50"	450-lb.	ea
MDSMPHS2	Medium	38" x 54"	450-lb.	ea
MDSMPHS3	Large	44" x 64"	450-lb.	ea
MDSMPHS4	X-Large	48" x 73"	700-lb.	ea

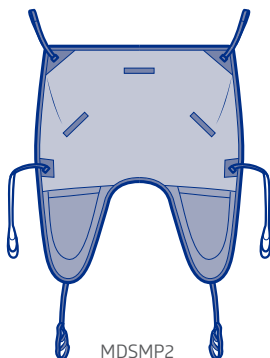

USE WITH  
6-PT.  
CRADLES

#### Without Head Support

Item No.	Size	Dimensions	Wt. Cap.	Pkg.
MDSMP2	Medium	38" x 50"	450-lb.	ea
MDSMP3	Large	44.5" x 51"	450-lb.	ea
MDSMP4	X-Large	46" x 59"	700-lb.	ea

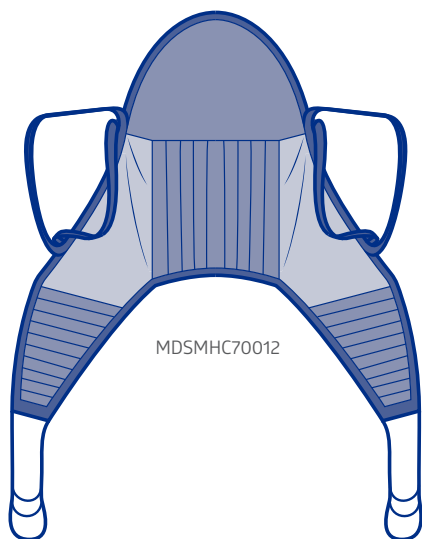

MDSMHC70012

USE WITH  
4-PT.  
CRADLES

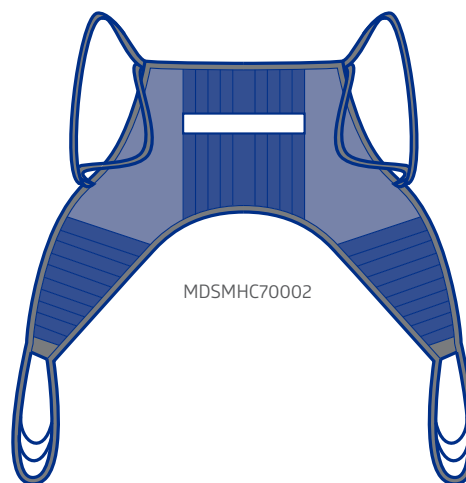

MDSMHC70002

USE WITH  
4-PT.  
CRADLES

## U-Shaped Padded Sling

*Knitted Fabric*

### RECOMMENDED USE

Patient transfers.

### With Head Support

Item No.	Size	Dimensions	Wt. Cap.	Pkg.
MDSMHC70012	Medium	37" x 47"	500-lb.	ea
MDSMHC70011	Large	41" x 57"	500-lb.	ea
MDSMHC70010	X-Large	46" x 60"	700-lb.	ea

### Without Head Support

Item No.	Size	Dimensions	Wt. Cap.	Pkg.
MDSMHC70002	Medium	34" x 36"	500-lb.	ea
MDSMHC70001	Large	41" x 57"	500-lb.	ea
MDSMHC70000	X-Large	46" x 46"	700-lb.	ea

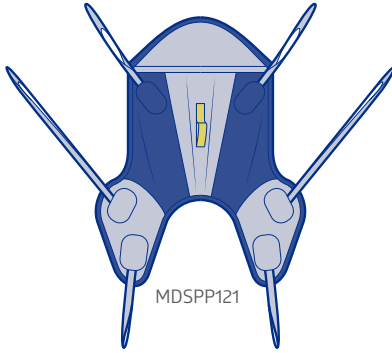

USE WITH  
4-PT.  
AND  
6-PT.  
CRADLES

### Pediatric Padded Sling

*Knitted Fabric*

#### RECOMMENDED USE

Transfers of pediatric patients over 35-lb. (16 kg).

Item No.	Size	Dimensions	Wt. Cap.	Pkg.
MDSPP121	One Size Fits Most	21" x 32"	100-lb.	ea



USE WITH  
STAND  
ASSIST  
LIFTS

### Stand-Assist Padded Sling

*Knitted Fabric/Flannel*

#### RECOMMENDED USE

Patient toileting and transfers with stand-assist lifts for extra support for standing.

Item No.	Size	Chest Circ.	Wt. Cap.	Pkg.
MDSMSA1	Small	28"-42"	500-lb.	ea
MDSMSA2	Medium	30"-48"	500-lb.	ea
MDSMSA3	Large	36"-60"	500-lb.	ea
MDSMSA4	X-Large	50"-79"	600-lb.	ea

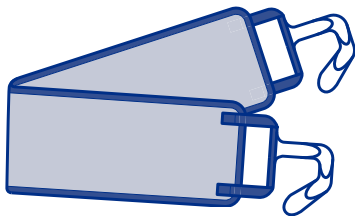

USE WITH  
STAND  
ASSIST  
LIFTS

### Stand-Assist Buttock Strap

*Knitted Fabric*

#### RECOMMENDED USE

An accessory for extra support with padded stand-assist slings.

Item No.	Size	Dimensions	Wt. Cap.	Pkg.
MDSMBSS	Standard	34" x 7"	400-lb.	ea
MDSMBSB	X-Large	58" x 11"	700-lb.	ea

# Padded flannel

Soft flannel provides a secure and easy fit as comfortable as your favorite shirt. Yet strong enough to support patients up to 450-lb.

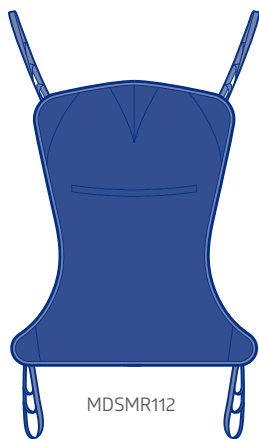
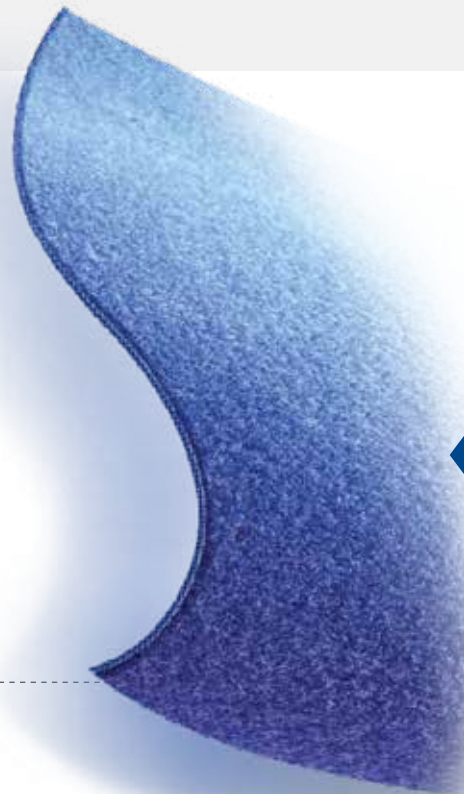

USE WITH  
4-PT.  
AND  
6-PT.  
CRADLES

MDSMR12

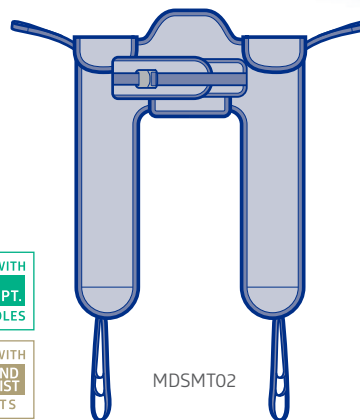

USE WITH  
4-PT.  
CRADLES

USE WITH  
STAND  
ASSIST  
LIFTS

MDSMT02

## Woven Padded Full-Body Sling

Flannel/Cordura

### RECOMMENDED USE

Routine lifting, especially for amputee patients.

Item No.	Size	Dimensions	Wt. Cap.	Pkg.
MDSMR112	Medium	30" x 47"	450-lb.	ea
MDSMR113	Large	34" x 52"	450-lb.	ea
MDSMR117	X-Large	36" x 57"	450-lb.	ea

## Padded Toilet Sling

Flannel/Knitted Fabric

### RECOMMENDED USE

Patient toileting. Can also be used with stand-assist lifts.

Item No.	Size	Chest Circ.	Wt. Cap.	Pkg.
MDSMT01	Small	26"-42"	450-lb.	ea
MDSMT02	Medium	30"-48"	450-lb.	ea
MDSMT03	Large	38"-60"	450-lb.	ea
MDSMT04	X-Large	58"-73"	450-lb.	ea

# Polypropylene

Cost-effective polypropylene slings are designed for single-patient use. The right choice for facilities concerned about slings not returning from the laundry.

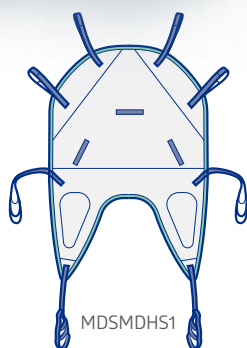

USE WITH  
6-PT.  
CRADLES

MDSMDHS1

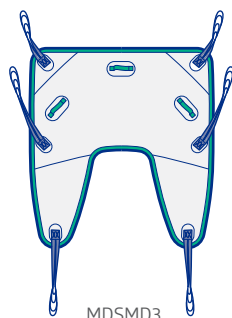

USE WITH  
6-PT.  
CRADLES

MDSMD3

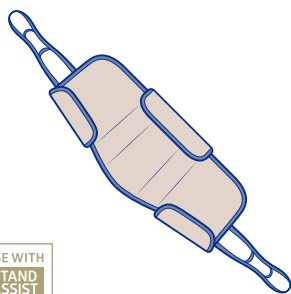

USE WITH  
STAND  
ASSIST  
LIFTS

MDSMDSA663

## U-Shaped Sling, Single-Patient Use

*Polypropylene*

### RECOMMENDED USE

Patient bathing and toileting.

### With Head Support

Item No.	Size	Dimensions	Wt. Cap.	Pkg.
MDSMDHS1	Small	33" x 49"	700-lb.	10/cs
MDSMDHS2	Medium	38.5" x 54"	700-lb.	10/cs
MDSMDHS3	Large	42.5" x 59"	700-lb.	10/cs
MDSMDHS4	X-Large	47" x 73"	700-lb.	10/cs

### Without Head Support

Item No.	Size	Dimensions	Wt. Cap.	Pkg.
MDSMD2	Medium	39" x 47"	700-lb.	10/cs
MDSMD3	Large	43" x 48"	700-lb.	10/cs

## Stand-Assist Sling, Single-Patient Use

*Polypropylene*

### RECOMMENDED USE

Patient toileting and transfers.

Item No.	Size	Chest Circ.	Wt. Cap.	Pkg.
MDSMDSA662	Medium	30"-48"	500-lb.	10/cs
MDSMDSA663	Large	36"-60"	500-lb.	10/cs

### Limb Lift Sling, Single-Patient Use

Polypropylene

**RECOMMENDED USE**

For lifting to provide care, or for ROM tasks.

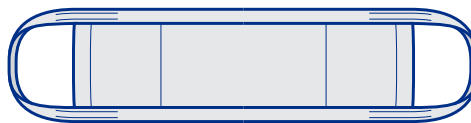

MDSLIMBLIFT

USE WITH  
**2-PT.**  
CRADLES

USE WITH  
**4-PT.**  
AND  
**6-PT.**  
CRADLES

Item No.	Size	Dimensions	Wt. Cap.	Pkg.
MDSLIMBLIFT	One Size Fits Most	40" x 6.5"	450-lb.	10/cs

### Low-Back Sling, Single-Patient Use

Polypropylene

**RECOMMENDED USE**

More active patients with lower acuity.

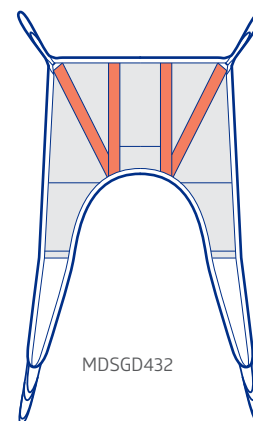

MDSGD432

USE WITH  
**2-PT.**  
CRADLES

Item No.	Size	Dimensions	Wt. Cap.	Pkg.
MDSGD432	Medium	38" x 39"	600-lb.	10/cs
MDSGD433	Large	40" x 44"	600-lb.	10/cs
MDSGD434	X-Large	41" x 47"	600-lb.	10/cs

### High-Back Sling, Single-Patient Use

Polypropylene

**RECOMMENDED USE**

More active patients with lower acuity.

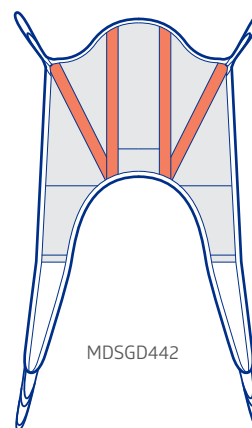

MDSGD442

USE WITH  
**2-PT.**  
CRADLES

Item No.	Size	Dimensions	Wt. Cap.	Pkg.
MDSGDH442	Medium	38" x 48"	600-lb.	10/cs
MDSGDH443	Large	39.5" x 54"	600-lb.	10/cs
MDSGDH444	X-Large	42" x 56"	600-lb.	10/cs

### U-Shaped Clip Sling, Single-Patient Use

Polypropylene

**RECOMMENDED USE**

Patient bathing and toileting.

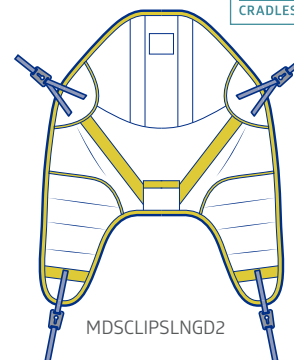

MDSCLIPSLNGD2

USE WITH  
**CLIP**  
CRADLES

Item No.	Size	Dimensions	Wt. Cap.	Pkg.
MDSCLIPSLNGD2	Medium	35" x 47"	600-lb.	10/cs
MDSCLIPSLNGD3	Large	38" x 51"	600-lb.	10/cs
MDSCLIPSLNGD4	X-Large	42" x 55"	600-lb.	10/cs



# Synthetic polyester

Support high weight capacities with polyester slings. Retains its color longer than traditional fabrics.

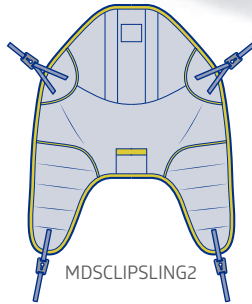

USE WITH  
**CLIP**  
CRADLES

## U-Shaped Clip Sling

*Polyester Fabric*

### RECOMMENDED USE

Patient bathing and toileting with clip-style positioning cradles.

Item No.	Size	Dimensions	Wt. Cap.	Pkg.
MDSCLIPSLING2	Medium	35" x 47"	600-lb.	ea
MDSCLIPSLING3	Large	38" x 51"	600-lb.	ea
MDSCLIPSLING4	X-Large	42" x 55"	600-lb.	ea

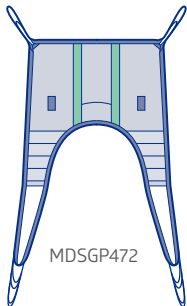

USE WITH  
**2-PT.**  
CRADLES

## Low-Back Sling

*Polyester Fabric*

### RECOMMENDED USE

With more active patients with lower acuity.

Item No.	Size	Dimensions	Wt. Cap.	Pkg.
MDSGP472	Medium	38" x 39"	600-lb.	ea
MDSGP473	Large	40" x 44"	600-lb.	ea
MDSGP474	X-Large	41" x 47"	600-lb.	ea

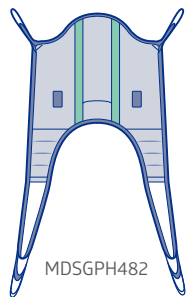

USE WITH  
**2-PT.**  
CRADLES

## High-Back Sling

*Polyester Fabric*

### RECOMMENDED USE

With more active patients with lower acuity.

Item No.	Size	Dimensions	Wt. Cap.	Pkg.
MDSGPH482	Medium	38" x 48"	600-lb.	ea
MDSGPH483	Large	39.5" x 54"	600-lb.	ea
MDSGPH484	X-Large	42" x 56"	600-lb.	ea

## Gait Training Sling

*Polyester Fabric*

### RECOMMENDED USE

Therapeutic treatments for regaining the ability to walk.

Item No.	Chest Circ.	Wt. Cap.	Pkg.
MDSMGAIT	40"-54"	300-lb.	ea

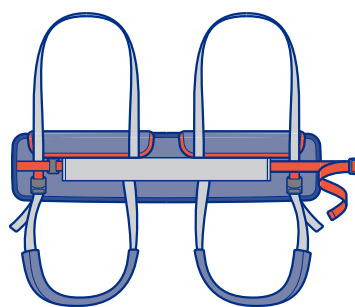

MDSMGAIT

USE WITH  
2-PT.  
CRADLES

## Single-Patient Use Repositioning Sling

*Polyester/Cotton Fabric*

### RECOMMENDED USE

Turning or repositioning patients in bed.

Item No.	Dimensions	Wt. Cap.	Pkg.
MDSTRIDR011	42" x 78"	1,100-lb.	10/cs

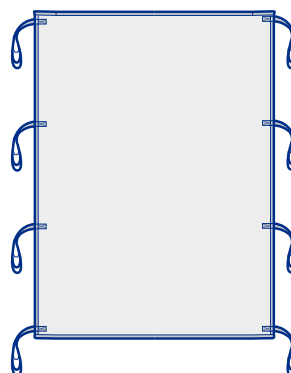

MDSTRIDR011

USE WITH  
4-PT.  
AND  
6-PT.  
CRADLES

## Reusable Repositioning Sling

*Polyester/Cotton Fabric*

### RECOMMENDED USE

Turning or repositioning patients in bed.

Item No.	Dimensions	Wt. Cap.	Pkg.
MDSTRIRR01	42" x 78"	1,100-lb.	ea

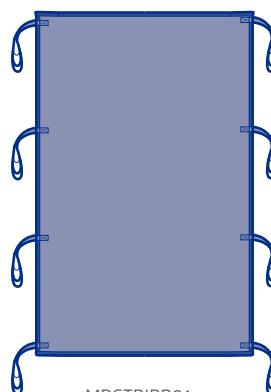

MDSTRIRR01

USE WITH  
4-PT.  
AND  
6-PT.  
CRADLES

# Reach a new level of safety.

## Safe Patient Handling Program

Reducing injury risks for nurses is one more way we're advancing the health of healthcare.

- » Complete, easy-to-implement training tools
- » High-quality medical equipment solutions with quick installation
- » Optional clinical support to assist with in-servicing
- » Assistance with writing policies, and assessments for OSHA compliance (see pages 5–6)
- » All at no cost to your facility with the purchase of a lift



Contact your Medline Representative for more information today.







Medline Industries, Inc. Three Lakes Drive, Northfield, IL 60093

Medline United States  
1-800-MEDLINE (633-5463)  
medline.com | info@medline.com

Medline Canada  
1-800-396-6996  
medline.ca | canada@medline.com

Medline México  
01-800-831-0898  
medlinemexico.com | mexico@medline.com

FOLLOW US    

References: **1.** Safe Patient Handling—Preventing Musculoskeletal Disorders in Nursing Homes. 2012. OSHA(3108). Available at: [www.osha.gov/Publications/OSHA3708.pdf](http://www.osha.gov/Publications/OSHA3708.pdf). Accessed May 15, 2017. **2.** Safe Patient Handling Programs: Effectiveness and Cost Savings. Occupational Safety and Health Association (OSHA). Available at: [www.osha.gov/Publications/OSHA3279.pdf](http://www.osha.gov/Publications/OSHA3279.pdf). Accessed May 17, 2017. **3.** Bureau of Labor Statistics. 2012. News release: Workplace injuries and illnesses—2011. Available at [www.bls.gov/news.release/archives/osh\\_10252012.pdf](http://www.bls.gov/news.release/archives/osh_10252012.pdf). Accessed May 17, 2017. **4.** Joint Commission on Accreditation of Healthcare Organizations (2002). Healthcare at the crossroads: Strategies for addressing the evolving nursing crisis. p 10. Oakbrook Terrace, IL. Available at: [www.jointcommission.org/assets/1/18/health\\_care\\_at\\_the\\_crossroads.pdf](http://www.jointcommission.org/assets/1/18/health_care_at_the_crossroads.pdf). Accessed May 17, 2017. **5.** Handle With Care Fact Sheet. American Nurses Association. Available at: [www.nursingworld.org/MainMenuCategories/ANAMarketplace/Factsheets-and-Toolkits/FactSheet.html](http://www.nursingworld.org/MainMenuCategories/ANAMarketplace/Factsheets-and-Toolkits/FactSheet.html). Accessed May 17, 2017. **6.** Aon Risk Solutions. 2012. 2012 Health Care Workers Compensation Barometer. See [www.aon.com/attachments/risk-services/2012-HC-WorkersComp\\_Barometer\\_Report\\_Abridged.pdf](http://www.aon.com/attachments/risk-services/2012-HC-WorkersComp_Barometer_Report_Abridged.pdf). Additional information about workers' compensation claims related to patient handling was provided by the authors to OSHA in 2013. **7.** Li, Y., and C.B. Jones. 2012. A literature review of nursing turnover costs. Journal of Nursing Management. 21(3): 405-418. (Dollar amounts presented in the text are in 2013 dollars. This is the range of the values presented in the studies calculated in 2013 dollars using the medical care portion of the consumer price index.) **8.** Safe Patient Handling Programs: Effectiveness and Cost Savings. Safety and Health Topics. Occupational Safety and Health Administration (OSHA). Available at <https://www.osha.gov/Publications/OSHA3279.pdf> Accessed on October 2, 2015. **9.** June 25, 2015 Memorandum: Inspection Guidance for Inpatient Healthcare Settings. Occupational Safety and Health Administration. Available at: [www.osha.gov/dep/enforcement/inpatient\\_insp\\_06252015.html](http://www.osha.gov/dep/enforcement/inpatient_insp_06252015.html). Accessed May 19, 2017. **10.** Cohen MH, Nelson GG, Green DA, Leib R, et al. Patient Handling and Movement Assessments: A White Paper. Prepared by the 2010 Health Guidelines Revision Committee Specialty Subcommittee on Patient Movement. Available at: [www.transmotionmedical.com/images/company\\_assets/4e7b62cf-2e05-4e0a-ad72-dc35e3c9d517/files/FGL\\_PHAMA\\_whitepaper\\_042810.pdf](http://www.transmotionmedical.com/images/company_assets/4e7b62cf-2e05-4e0a-ad72-dc35e3c9d517/files/FGL_PHAMA_whitepaper_042810.pdf). Accessed May 19, 2017. **11.** Average force required to initiate slide. Data on file. Available upon request. **12.** WVTR Test for Breathability. Data on file. Available upon request. **13.** Data on file. Available upon request. **14.** Drypad performance. Data on file. Available upon request. **15.** Mellson J, Richardson N. The Impact of Hoist Sling Fabrics on Gluteal Interface Pressure While Sitting in Healthy Individuals: A Controlled Pre-Post Test Study. American Journal of SPHM (Safe Patient Handling and Movement). 2012;2(3):79-85. Available at: [www.americanjournalofsphm.com/shop\\_ajsphm/index.php?route=product/product&product\\_id=88](http://www.americanjournalofsphm.com/shop_ajsphm/index.php?route=product/product&product_id=88). Accessed May 30, 2017.

Some products may not be available for sale in Mexico or Canada. We reserve the right to correct any errors that may occur within this brochure. © 2017 Medline Industries, Inc. All rights reserved. ComfortRise is a trademark, and Medline, Comfort Glide and UltraSorbs are registered trademarks of Medline Industries, Inc. MKT1790810 / LIT293R / 4M / SG43