

Rechargeable OTC Hearing Aids

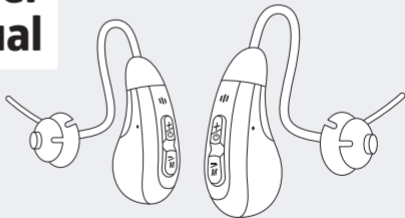

User Manual



REF MDSHEAR AidWT1

Not made with Natural Rubber Latex

Warnings

Warnings: If you are younger than 18, do not use this.

You should go to a doctor, preferably an ear, nose and throat doctor (an ENT), because your condition needs specialized care. Over-the-counter hearing aids are only for users who are age 18 and older.

This OTC hearing aid is for users who are 18 and older. People who are younger than 18 with hearing loss should see a doctor, preferably and ENT, because they may need medical testing and management. Hearing loss can affect speech and learning, so professional fitting and continuing care are also important.

Warnings: When to See a Doctor.

If you have any of the problems listed below, please see a doctor, preferably an ear-nose-throat doctor (an ENT).

- Your ear has a birth defect or an unusual shape. Your ear was injured or deformed in an accident.
- You saw blood, pus, or fluid coming out of your ear in the past 6 months.
- Your ear feels painful or uncomfortable.
- You have a lot of ear wax, or you think something could be in your ear.
- You get really dizzy or have a feeling of spinning or swaying (called vertigo).
- Your hearing changed suddenly in the past 6 months.
- Your hearing changes: it gets worse then it gets better.
- Your have worse hearing in one ear.
- You hear ringing or buzzing only in one ear.

Warnings: This hearing aid should not cause pain when inserting it.

Remove this device from your ear if it causes pain or discomfort when you insert or place it. To try again, make sure to follow the instructions. If you feel pain or discomfort again, contact the manufacturer. If your pain or discomfort doesn't go away, contact your hearing healthcare professional. You can also report this to FDA as an adverse event according to the instructions that appear later.

WARNING: Do not use if any of the following apply to you

- Congenital atresia of external ear or deformity of any part of the ear canal.
- Deafness is unstable, and the degree of hearing loss often fluctuates.
- Persistent headaches, dizziness, earaches, tinnitus, or other symptoms that are not suitable for adaptation.
- Sudden onset of hearing loss within the past 3 months; rapid progressive deafness; unilateral hearing loss; or other acute ear diseases.
- Effusion (secretions/discharge) in the ear and/or frequent purulence (pus).
- Central deafness (central nervous system) or non-organic deafness.
- Patients with acute otitis externa and tympanitis.
- Patients with acute and chronic suppurative otitis media (in the period of purulent infection).
- Patients who are allergic to the materials of this product.

WARNING: Important safety instructions

- Keep small parts (hearing instrument, ear tips, battery, or other

detachable parts) that can be swallowed out of reach of children.

- Dropping, immersing in liquid, exposure to strong electromagnetic fields or excessive heat will damage the hearing aid. Remove devices prior to any type of X-Ray, MRI, or CT scan.
- If parts become stuck in the ear canal, seek medical assistance. Do not attempt to remove by yourself.
- Do not use at high volume for extended periods of time, as this can result in ear injury.
- If you experience any pain or strong discomfort using the devices, remove and consult a doctor.
- Routine maintenance to keep the device clean is required. Ensure that ear tips are free of debris and moisture at all times.
- Do not store or use the product in environments of high humidity or temperature (such as sauna rooms) to avoid damage.
- Batteries should be recycled properly and not disposed of in the trash.
- Keep the devices away from children. Injury or damage may result.
- Do not share your hearing aids with others. Using a hearing aid configured for someone else can result in hearing damage or injury.
- Monitor for any unusual skin reaction. If you notice any allergic reaction (itchiness, swelling, or rash) stop wearing the hearing aids and consult a medical specialist.
- Stay away from strong electromagnetic fields when using the hearing aids to avoid unexpected damage. Your hearing aids are delicate electronic instruments and may be damaged by contact with strong magnetic equipment such as electromagnetic ovens, microwave ovens, ultrasonic cleaners, etc.

- If the Bluetooth function is available for your device, do NOT connect the hearing aid and headsets to the mobile phone via Bluetooth simultaneously – noise, distortion, or other unexpected problems may occur to your hearing aid.
- Please contact the MANUFACTURER:
 - For assistance, if needed, in setting up, using, or maintaining your devices, or to report any unexpected operation or events.
- Contact your hearing professional for assistance if needed.
- Do NOT fix your devices by yourself. Doing so will not only void the warranty but also cause further damage easily. Check the TROUBLESHOOTING GUIDE first when failures occur to your devices.

Cautions & Notices

Caution: This is not hearing protection.

You should remove this device if you experience overly loud sounds, whether short or long-lasting. If you're in a loud place, you should use the right kind of hearing protection instead of wearing this device. In general, if you would use ear plugs in a loud place, you should remove this device and use ear plugs.

Caution: The sound output should not be uncomfortable or painful.

You should turn down the volume or remove the device if the sound output is uncomfortably loud or painful. If you consistently need to turn the volume down, you may need to further adjust your device.

Caution: You might need medical help if a piece gets stuck in your ear.

If any part of your hearing aid, like the eartip, get stuck in your ear, and you can't easily remove it with your fingers, get medical help as soon as you can. You should not try to use tweezers or cotton swabs because they can push the part farther into your ear, injuring your eardrum or ear canal, possibly seriously.

Note: If you remain concerned, consult a professional.

If you try this device and continue to struggle with or remain concerned about your hearing, you should consult with a hearing healthcare professional.

Note: What you might expect when you start using a hearing aid.

A hearing aid can benefit many people with hearing loss. However, you should know it will not restore normal hearing, and you may still have some difficulty hearing over noise. Further, a hearing aid will not prevent or improve a medical condition that causes hearing loss.

People who start using hearing aids sometimes need a few weeks to get used to them. Similarly, many people find that training or counseling can help them get more out of their devices.

If you have hearing loss in both ears, you might get more out of using hearing aids in both, especially in situations that make you tired from listening - for example, noisy environments.

Note: Tell FDA about injuries, malfunctions, or other adverse events.

To report a problem involving your hearing aid, you should submit information to FDA as soon as possible after the problem. FDA calls them

“adverse events”, and they might include: skin irritation in your ear, injury from the device (like cuts or scratches, or burns from an overheated battery), pieces if the device getting stuck in your ear, suddenly worsening hearing loss from using the device, etc.

Instruction for reporting are available at <https://www.fda.gov/Safety/Medwatch>, or call 1-800-FDA-1088. You can also download a form to mail to FDA.

Note: If you experience side effects, contact a hearing care professional.

Possible side effects from wearing the hearing aid may include:

- Dizziness
- Tinnitus
- Perceived worsening of hearing loss
- Nausea
- Headache
- Skin reaction
- Excessive ear wax accumulation

Note: Tips for better communication

It will take practice, time, and patience for your brain to adapt to the new sounds that your hearing aids provide. Hearing is only part of how we share thoughts, ideas and feelings. Reading lips, facial expressions, and gestures can help the learning process and add to what amplification alone may miss.

1. Please review the following simple communication tips for you:
 - Move closer to and look at the speaker.

- Sit face-to-face in a quiet room if possible.
 - Try out different locations to find the optimal places to listen
 - Minimize distractions.
 - Background noises may be frustrating at first; remember, you have not heard them for a while.
 - Let others know what you need; keep in mind that people cannot “see” your hearing loss.
 - Develop realistic expectations of what your hearing aids can and cannot do.
 - Better hearing with hearing aids are a learned skill combining desire, practice, and patience
2. You will learn and adjust, it just takes a little time. Remember to be patient with yourself.
 3. Your family and friends are also affected by your hearing loss. For your family and friends, request that they:
 - Get your full attention before beginning to speak.
 - Look at you or sit face-to-face.
 - Speak clearly and at a normal rate and level; shouting can actually make understanding more difficult.
 - Rephrase rather than repeat the same words; different words may be easier to understand.
 - Minimize distractions while speaking.

Note: Additional cautions

- The use of accessories and cables other than those specified by manufacturer, with the exception of cables sold by manufacturer as

replacement parts for internal components, may result in increased emission or decreased immunity of the device.

- Do not use a mobile phone or other devices that emit electromagnetic fields, near the unit. This may result in incorrect operation of the unit.
- Do not bring the device into any MRI, CT, diathermy, RFID and electromagnetic security systems such as metal detectors environment or near any of this equipment. Consult manufacturer if you have any questions.
- This device should not be used adjacent to or stacked with other equipment and that if adjacent or stacked use is necessary, this device should be observed to verify normal operation in the configuration in which it will be used.
- Refer to further guidance below regarding the EMC environment in which the device should be used.

There is no guarantee that interference will not occur in a particular installation. Radiated or conducted electromagnetic signals can cause:

1. As to devices:

- Deviation of the values of pulse duration, amplitudes, and repetition frequencies, may impair the unit's essential performance. The device has passed EMC highest interference level test, and the parameters do not deviate the essential performance requirement.
- The device displays abnormally.

2. As to patients:

- The sensitivity of stimulation may be weaker or stronger, but it does not produce safety issues.
- Cannot achieve expected effect.

If this equipment is found to cause or respond to interference, attempt to correct the problem by one or more of the following measures:

- If feeling too weak or too strong stimulation, adjust the strength level to an acceptable level.
- If the device display is abnormal, power off and restart the device and check whether it shows properly.
- Re-orient or re-locate the affected device.
- Increase the separation between the unit and the affected device.
- Power the equipment from a source other than that of the affected device.
- Consult the service representative for further suggestions.

Table of Contents

0. Warnings & Cautions	2
1. Getting To Know Your Hearing Aids	13
1.1 Contents	13
1.2 Hearing Aids Parts Identification	13
1.2.1 Left & Right Hearing Aid Markings	14
1.3 Charging Case Parts Identification	14
1.4 Accessories Identification	15
2. Instruction For Insertion Depth	16
3. Using The Charging Function	17
3.1 Charging the Hearing Aids	17
3.2 Charging the Charging Case	18
3.3 Notes on Charging	19
4. Using The Hearing Aids	20
4.1 Selecting & Installing Ear Tips	20
4.2 Turning the Hearing Aids ON/OFF	21
4.2.1 Turning ON the Hearing Aid	21
4.2.2 Turning OFF the Hearing Aid	22
4.3 Wearing/Removing the Hearing Aids	22
4.3.1 Wearing the Hearing Aids	22
4.3.2 Removing the Hearing Aids	23
4.3.3 Notes on Wearing/Removing the Hearing Aids	23

4.4 Controlling the Hearing Aid Volume	24
4.5 Switching Between Hearing Aid Environmental Settings	24
5. Caring For The Hearing Aids	26
5.1 Cleaning the Hearing Aids	26
5.2 Replacing the Thin Tubing	27
5.2.1 Removing the Thin Tubing	27
5.2.2 Installing the New Thin Tubing	27
5.3 Notes on Caring for the Hearing Aids	28
6. Further Information	30
6.1 Troubleshooting	30
6.1.1 Hearing Aids Troubleshooting	30
6.1.2 Charging Case Troubleshooting	32
6.2 Technical Specifications	33
6.2.1 Additional Technical Specifications	35
6.3 Normalized Symbols	47
6.4 Maintenance, Storage, and Disposal	48
6.5 Warranty	49
6.6 Warranty Return	50

1. Get To Know Your Device

1.1 Contents

Left & right hearing aids, charging case, USB charging cable, cleaning tool, four (4) ear tips, instruction manual

1.2 Hearing Aids Parts Identification

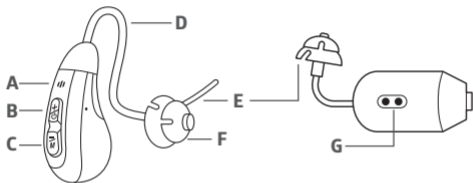

A. Microphone – where sound enters the hearing aids

B. ON/OFF/VOLUME UP – button to increase volume and turn the hearing aid ON/OFF

C. SETTING/VOLUME DOWN – button to decrease volume, switch between hearing aid environmental programs.

D. Thin Tubing – connects the ear tip to hearing aid

E. Stabilizer Bar – helps prevent the ear tip from moving out of ear canal

F. Ear Tip – soft silicon domes which hold the hearing aid comfortably and securely in the ear canal

G. Charging Contacts – where hearing aids receive power when charging

1.2.1 Left & Right Hearing Aid Markings

- There is a red or blue marking on the thin tubing which helps to distinguish between left and right hearing aid
- Blue marking is for the left hearing aid
- Red marking is for the right hearing aid

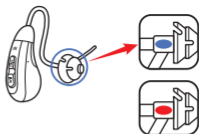

1.3 Charging Case Parts Identification

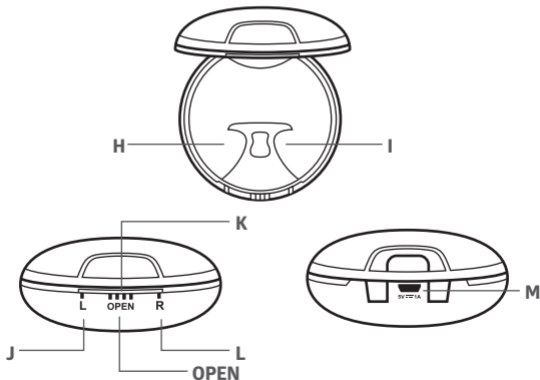

- H. Charging Slot for Left Hearing Aid** - charges and stores hearing aid (L)
- I. Charging Slot for Right Hearing Aid** - charges and stores hearing aid (R)
- J. Indicator Light for Left Hearing Aid** - displays the charging status of hearing aid (L)
- K. Indicator Light for Charging Case** - displays the charging status of charging case
- L. Indicator Light for Right Hearing Aid** - displays the charging status of hearing aid (R)
- M. Charging Port** - location where the USB cable connects to charge the charging case

1.4 Accessories Identification

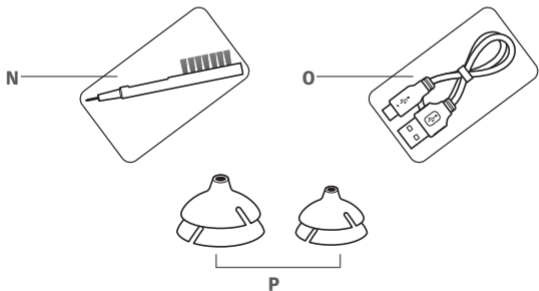

N. Cleaning Tool – used to clean hearing aids, ear tips, and charging case

O. USB Type-C Charging Cable – used to charge the charging case and hearing aids.

P. Ear Tips – soft silicon domes which hold the hearing aid comfortably and securely in the ear canal. For this hearing aid model, ear tips come in two (2) sizes. Each ear tip is part of a pair, for a total of 4 included ear tips.

2. Instruction For Insertion Depth

- OTC regulations state the lower limit distance from the tympanic membrane (eardrum) to the hearing aid must be at least 1 cm
- For adults, the average length of the ear canal has been estimated to be 2.3-2.8 centimeters (cm)
- The maximum insertion depth this hearing aid reaches is 1.15 cm
- So, the minimum possible distance between the tympanic membrane (eardrum) and the hearing aid is 1.15 cm, which meets and exceeds the OTC regulation
- Therefore, the device is safe and complies with OTC regulations.

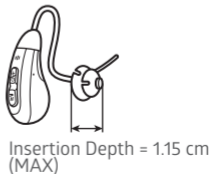

3. Using The Charging Function

3.1 Charging the Hearing Aids

Note: The notification “Battery Low” will play through the hearing aid(s) when the hearing aid battery is almost depleted.

Please read and follow the steps below to charge the hearing aids.

1. Before charging, turn off your hearing aids by pressing and holding ON/OFF/VOLUME UP until you hear “Beep-Beep-Beep”. Then, release the button
2. Place the hearing aids into the correct slot of the charging case
 - The left & right hearing aids are slot-specific, meaning they will only fit in the appropriate slot
3. The hearing aids will start charging automatically. You can verify charging is occurring based on the light indicator(s) on either side the charging case
 - A blue light on either hearing aid indicator means that specific hearing aid is charging
 - A white light on either hearing aid indicator means that specific hearing aid is fully charged. The indicator lights will turn off after ~2 hours.

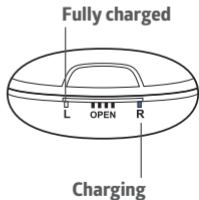
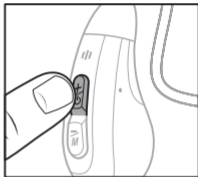







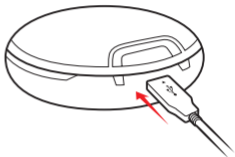
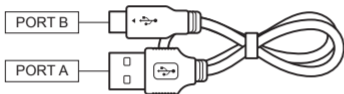





3.2 Charging the Charging Case

Please read and follow the steps below to charge the charging case.

1. Connect Port B of the USB Type C to the Charging Port of the charging case
2. Connect Port A of the USB cable to the power supply (see section 6.2.1 Additional Technical Specifications for details on ideal power supply)



3. The charging case will begin charging automatically. You can verify charging is occurring based on the light indicator(s) on the charging case.
 - There are four (4) blue LED indicator lights on the charging case that show the charging or remaining battery capacity of the charging case.
 - These indicator lights will either illuminate solid blue, flashing blue, or no light depending on the charging case battery status
 - Please read the following charging case battery status table for detailed information on what the different indicator light patterns mean

 Flashing  Stop  Solid blue light		
Charging status of charging case	Remaining battery capacity	Indicator lights for charging case
Charging case in charging	100%	
	75%-100%	
	50%-75%	
	25%-50%	
	0%-25%	
Charging case is not charging	100%	
	75%-100%	
	50%-75%	
	25%-50%	
	0%-25%	

*The battery capacity data above is derived from the measured value of the product in a laboratory setting and is not guaranteed value

3.3 Notes on Charging

- You can charge the charging case and the hearing aids simultaneously
- Each hearing aid (left & right) charge independently and separately; make sure you charge both hearing aids if you intend to use both hearing aids
- You can only charge the hearing aids via the charging case; you cannot charge the hearing aids directly
- The charging case will charge the hearing aids regardless of if the case is open or closed. The charging process will stop automatically when

the case and hearing aids are fully charged or when the hearing aids are removed

4. Using The Hearing Aids

4.1 Selecting & Installing Ear Tips

CAUTION: Selecting the incorrect ear tip size or installing the ear tips incorrectly can result in the ear tip remaining stuck in the ear canal, which may result in damage to the ear / hearing ability.

Be sure to read and follow all the steps below to properly select a suitable ear tip size and install the ear tips on the hearing aid.

1. Select a suitably-sized ear tip.
 - A suitably-sized ear tip should feel comfortable and fit snugly in your ear canal with little chance of falling out. It should also produce no feedback or whistling when worn.
 - You may have to try multiple ear tip sizes to find the best fit.
 - This hearing aid comes with two (2) ear tip sizes. See below for the ear tip sizes.
2. Push the selected ear tip rim membrane inside out



Large



Small

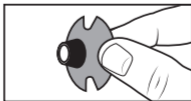

3. Hold the end of the hearing aid thin tubing. Then, firmly push the ear tip against the thin tubing to securely fasten the ear tip

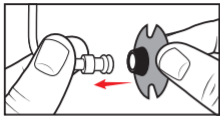

4. Confirm the ear tip is secure and correctly installed by gently pulling on the ear tip. If the ear tip comes off, it is not secure. Repeat steps 2 and 3 to reinstall the ear tip.
5. Repeat steps 1-4 to select and install an ear tip on the second hearing aid.

4.2 Turning the Hearing Aids ON/OFF

4.2.1 Turning ON the Hearing Aid

1. Press and hold ON/OFF/VOLUME UP until you hear “Beep-Beep-Beep”.
 - You will also hear a tone based on the current hearing aid environmental setting (see section 4.5 Switching Between... Environmental Settings)

2. Release ON/OFF/VOLUME UP

Note: If your hearing aids will not turn on, you may need to charge them. Please refer to section 3.

USING THE CHARGING FUNCTION for instructions on how to charge the hearing aids

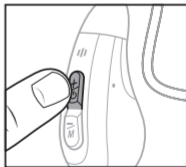

4.2.2 Turning OFF the Hearing Aid

- Press and hold ON/OFF/VOLUME UP until you hear “Beep-Beep-Beep”
- Release ON/OFF/VOLUME UP

4.3 Wearing/Removing the Hearing Aids

4.3.1 Wearing the Hearing Aids

1. Before wearing the hearing aids, make sure you have completed every step in section 4.1 Selecting and Installing Ear Tips
2. Hold the thin tubing at the point where it attaches to the ear tip
3. Gently push the ear tip into the ear canal

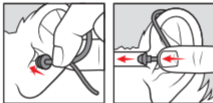

4. Place the hearing aid over the top of your ear
5. Tuck the stabilizer bar in your ear so it curves up following the path of your antitragus (the vertical middle ridge of your ear). The stabilizer bar should rest in a “C” shape after placement.
6. Repeat the steps above for the second hearing aid (if applicable)
7. Press and hold ON/OFF/VOLUME UP to turn on the hearing aid(s)



Stabilizer bar

4.3.2 Removing the Hearing Aids

1. Turn off the hearing aid by pressing and holding ON/OFF/VOLUME UP until you hear “Beep-Beep-Beep”
2. Remove the stabilizer bar from the bottom of your auricle
3. Gently pull the ear tip out and away from your ear canal
4. Take the hearing aid away from your ear
5. Repeat the steps above for the second hearing aid (if applicable)

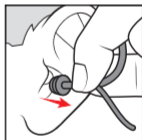
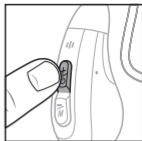

4.3.3 Notes on Wearing/Removing the Hearing Aids

- The hearing aids will whistle when inserted incorrectly or incompletely. If you hear this noise, reinsert the hearing aids correctly
- If whistling noise remains after reinsertion, replace the ear tips with the larger size ear tips
- Whistling can also occur due to feedback while positioning the hearing aid. This should stop once positioning is complete
- Whistling can also be caused by an excessive amount of earwax.
- When wearing the hearing aids, the stabilizer bar should NOT stick out, go in the ear canal, nor curve below the ear lobe.
- If you are still experiencing difficulties, see section 6.1 Troubleshooting for more information

4.4 Controlling the Hearing Aid Volume

- The hearing aids have eleven (11) volume levels
- You can increase the volume by pressing ON/OFF/ VOLUME UP one time
- You can decrease the volume by pressing SETTING/ VOLUME DOWN one time
- Do NOT press and hold the button(s) to change the volume (this would change environment setting)
- Each time you adjust the volume you will hear a “Beep” tone
- You will hear the prompt tone “Beep-Beep-Beep” at maximum and minimum volume.
- The volume on each hearing aid is controlled independently.
 - Changing the volume on hearing aid (L) does NOT change the volume on hearing aid (R), or vice versa
- You can set each hearing aid to a unique volume level
- To set both hearing aids to the same volume level, you must adjust them manually

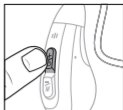

Volume up



Volume down

4.5 Switching Between Hearing Aid Environmental Settings

- The hearing aids come with four (4) preset environmental settings
- These settings are designed to help you hear better in different environments
 - Example: You would set the hearing aid to the “Restaurant” setting to improve hearing when you are in a restaurant

- The hearing aids are always in one of the environmental settings
- The “Standard” environmental setting is the standard hearing aid mode for day-to-day hearing
- To switch between the different hearing aid environmental settings, while the hearing aids are turned on, press and hold SETTING/VOLUME DOWN until you hear one of the environmental setting prompt tones. Then release the button.
- The hearing aids have a memory for the last-set environmental setting:
 - When the hearing aids are turned off, they remember the last-set setting and automatically enter that setting when turned back on
- The table below summarizes the different hearing aid environmental settings and the prompt tone you will hear for each when switching between settings



Environmental Setting		Prompt Tone
1	Standard	“Beep”
2	Restaurant	“Beep-Beep”
3	Outdoor	“Beep-Beep-Beep”
4	Music	“Beep-Beep-Beep-Beep”

5. Caring For The Hearing Aids

5.1 Cleaning the Hearing Aids

- Inspect the hearing aids, ear tips, and charging case regularly
- You can remove earwax from the ear tips by using the included cleaning tool
- You can also use a clean cloth to remove any additional debris from the ear tips

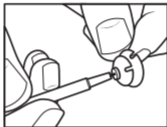
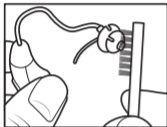

- You can also use the included cleaning tool to clean the charging case
- Regularly use a clean cloth to clean the charging contacts on the hearing aids and charging case. This will ensure normal charging functionality

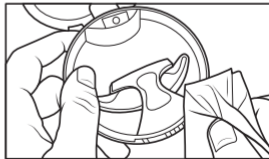
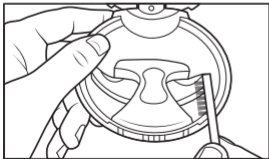

- Ear tips should be replaced every 3-6 months or when they become stiff, brittle, or discolored

5.2 Replacing the Thin Tubing

Hearing aid thin tubing should be replaced if the tubing is dirty/yellow or you notice a decrease in the quality of the hearing aids.

5.2.1 Removing the Thin Tubing

1. Use one hand to hold the hearing aid and one hand to hold the thin tubing base
2. Rotate the thin tubing base ~180 degrees to the left
3. Gently pull the thin tubing base up and away from the hearing aid

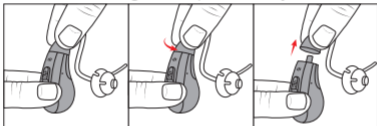

5.2.2 Installing the New Thin Tubing

1. Use one hand to hold the hearing aid and one hand to hold the new thin tubing base
2. Gently push the thin tubing base down onto the hearing aid point, making sure the thin tubing and hearing aid are aligned properly
3. Confirm the thin tubing is firmly connected by gently pulling on the thin tubing. If it comes loose, repeat the steps above to reinstall.

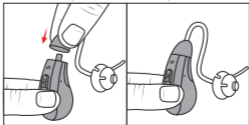

5.3 Notes on Caring for the Hearing Aids

Please read and follow the advice below for the best user experience and to prolong the life of your devices.

- Do not drop your hearing aids or knock them against hard surfaces.
- Do not submerge your hearing aids nor charging case in any liquid, including water.
- Do not use sharp tools to dislodge ear wax. Sticking household items into your devices can seriously damage them.
- Keep your devices away from high-temperature and/or high-humidity atmosphere.
- Keep your devices clean and dry by using cleaning cloth, to avoid potential damage from humidity or perspiration.
- Do not swim, shower or sauna while wearing the hearing aids.
- Your devices should never be rinsed or submerged in water as water drops may block sound or damage the electrical components of the hearing aids.
- Do not attempt to dry the hearing aids or charging case in an oven, microwave or other heating equipment. This will cause them to melt and may cause burns to your skin.
- Do not clean your devices with water, solvent or cleaning fluids.
- Always remove your hearing aids when using hair care products. The hearing aids can become clogged and cease to function properly.
- Store your devices in a clean and dry location.
- Do not use the electronic dryer to store the rechargeable hearing aids.

- Inspect the hearing aids, ear tips, and charging case regularly. Remove earwax and debris from your devices by using enclosed cleaning tools.
- Clean the charging contacts of the rechargeable hearing aids with cleaning cloth regularly to ensure the normal charging.
- Ear tips should be replaced every 3-6 months or when they become stiff, brittle, or discolored.
- The hearing aids have IP54 limited protection against ingress of dust and water. Avoid the earbuds getting exposed to extensive dust or water. Do not swim, shower or sauna while wearing the earbuds. Earbuds have an IP54 rating as tested against standard IEC 60529: Degrees of protection provided by enclosures (IP code).

6. Further Information

6.1 Troubleshooting

6.1.1 Hearing Aids Troubleshooting

Issue	Possible Causes	Potential Solution
Feedback or Whistling	Hearing aids may be worn incorrectly in the ear	Ensure hearing aid placement in the ear is correct (ref: section 4.3.1)
	Volume may be too loud	Press the SETTING/VOLUME DOWN button
	Ear tips may be broken or clogged	Replace ear tips (ref: section 4.1)
	An object may be too close to the hearing aids	Try to introduce space between hearing aids and object(s)
	Ear may be full of wax	Visit your physician

Issue	Possible Causes	Potential Solution
No Sound	Not pressing & holding ON/OFF/VOLUME UP long enough	Press & hold ON/OFF/VOLUME UP until you hear “Beep-Beep-Beep” (ref: section 5.1)
	Battery may not be fully charged	Charge the hearing aids (ref: section 3.1)
	Microphone may be clogged	Clean debris or earwax from hearing aid microphone (ref: section 5.1)
	Hearing aids may have low battery	Charge the hearing aids (ref: section 3.1)
Sound is Weak or Fuzzy	Volume may be too low	Increase volume by pressing ON/OFF/VOLUME UP
	Microphone may be clogged	Clean debris or earwax from hearing aid microphone (ref: section 5.1)

6.1.2 Charging Case Troubleshooting

Issue	Possible Causes	Potential Solution
Charging Case Indicator Light Not Illuminating or Flashing	Adapter may not be powered	Power the adapter or re-plug to the power supply
	Battery may be over-discharging	Charge the charging case and ensure it is charged for the correct amount of time
Charging Case Cannot Charge Hearing Aids	Hearing aids may be inserted in the incorrect slot of charging case	Insert hearing aids into appropriate slot depending on if hearing aid is left-side or right-side
	Charging contacts may be dirty	Clean the charging contacts on the hearing aids and charging case (ref: section 5.1)

6.2 Technical Specifications

- Test Standard: ANSI 3.22-2014
- Test Equipment: FONIX 8000
- Test Coupler: HA-2

The standard test ambient conditions shall be:

- Temperature: 23 °C \pm 5 °C (73° \pm 9°F)
- Relative humidity: 0% to 80%
- Atmospheric pressure: 760(+37.5,-150)mm of Hg or 101.3(+5,-20) kPa

Operation environment:

- Temperature: -10°C~40°C
- Relative humidity: 30%~75%
- Atmospheric pressure range: 86~106kPa

Storage & transportation environment:

- Temperature: -10°C~+55°C
- Relative humidity: 10%~90%
- Atmospheric pressure range: 70~106kPa

1. OTC Hearing aids technical specification	
Test items	Program 1
Max. Output (OSPL90)	115dB
The full-on gain value (HFA FOG@50)	26dB
The total harmonic distortion value (THD)	2%
The self-generated noise value (EIN)	28dB
The Latency value	14ms
Frequency response bandwidth	F1=200Hz F2=5500Hz
Frequency response smoothness	9dB

2. Battery life & Discharge time of charging case	
Test items	Value
Battery life of hearing aids	20h
A pair of hearing aids charging time with fully charging case	3 times

The data are derived from the measured value of the product at the laboratory, not guaranteed values. All rechargeable batteries have a limited lifespan – eventually their capacity and performance decline such that they need to be replaced. As batteries age, it can contribute to changes in your OTC Hearing Aid performance.

6.2.1 Additional Technical Specifications

- Input Voltage: 100-240 V, ~50/60 Hz, 0.2A
- Output: 5 V --- 1 A
- Time it takes to fully charge battery from empty: ≤ 2.5 hours

This box contains the following

Hearing aid	Li-ion Rechargeable battery x 2
Charging case	Li-ion Rechargeable battery x 1

Important information regarding Electro Magnetic Compatibility (EMC)

With the increased number of electronic devices such as PC and mobile (cellular) telephones, radio transceivers, mobile radio transmitters, radio-controlled toys, and so on, Medical devices in use may be susceptible to electromagnetic interference from other device. Electromagnetic interference may result in incorrect operation of the medical devices and create a potentially unsafe situation. Medical devices should also not interfere with other devices.

In order to regulate the requirements for EMC (Electro Magnetic Compatibility) with the aim to prevent unsafe product situations, the EN60601-1-2 standard has been implemented. This standard defines the levels of immunity to electromagnetic interference as well as maximum levels of electromagnetic emissions for medical devices.

This unit has been thoroughly tested and inspected to assure proper performance and operation! This product needs special precautions regarding EMC and needs to be installed and put into service according to the EMC information provided, the following tables recommend minimum separation distances between portable and mobile RF communications equipment and the RJADAT-1 unit.

1. Guidance and manufacturer's declaration-electromagnetic emission-for all EQUIPMENT and SYSTEMS.

1	Guidance and manufacturer's declaration-electromagnetic emission		
2	Rechargeable OTC Hearing Aids are intended for use in the electromagnetic environment specified below. The customer of the user of Rechargeable OTC Hearing Aids should assure that it is used in such an environment.		
3	Emission test	Compliance	Electromagnetic environment guidance
4	RF emissions CISPR 11	Class B Group 1	Rechargeable OTC Hearing Aids use RF energy only for its internal function. Therefore, its RF emissions are very low and are not likely to cause any interference in nearby electronic equipment.

5	RF emissions CISPR 11	Class B Group 1	Rechargeable OTC Hearing Aids are suitable for use in all establishments, other domestic establishments and those directly connected to the public low- voltage power supply network that supplies buildings used for domestic purposes.
6	Class B	Class A	
7	Voltage fluctuations/ flicker emissions IEC 61000-3-3	N/A	

2. Guidance and manufacturer's declaration-electromagnetic immunity-for all EQUIPMENT and SYSTEMS.

Guidance and manufacturer's declaration-electromagnetic immunity

Rechargeable OTC Hearing Aids are intended for use in the electro-magnetic environment specified below. The customer or the user of Rechargeable OTC Hearing Aids should assure that it is used in such an environment.

Immunity test	IEC 60601 test level	Compliance level	Electromagnetic environment guidance
Electrostatic discharge (ESD) IEC 61000-4-2	Contact discharge: ± 8 kV Air discharge: ± 2 kV, ± 4 kV, ± 8 kV, ± 15 kV	Contact discharge: ± 8 kV Air discharge: ± 2 kV, ± 4 kV, ± 8 kV, ± 15 kV	Floors should be wood, concrete or ceramic tile. If floor are covered with synthetic material, the relative humidity should be at least 30%

<p>Electrical fast transient/burst IEC 61000-4-4</p>	<p>±2 kV for power supply lines ±1 kV for input/output lines</p>	<p>N/A</p>	<p>Mains power quality should be that of a typical commercial or hospital environment.</p>
<p>Surge IEC 61000-4-5</p>	<p>±1 kV differential mode ±2 kV common mode</p>	<p>N/A</p>	<p>Mains power quality should be that of a typical commercial or hospital environment.</p>

<p>Voltage dips, short interruptions and voltage variations on power supply input lines IEC 61000-4-11</p>	<p><5% UT (>95% dip in UT) for 0.5 cycle</p> <p>40% UT (60% dip in UT) for 5 cycles</p> <p>70% UT (30% dip in UT) for 25 cycles</p> <p><5% UT (>95% dip in UT) for 5 sec</p>	<p>N/A</p>	<p>Mains power quality should be that of a typical commercial or hospital environment. If the user of Rechargeable OTC Hearing Aids require continued operation during power mains interruptions, it is recommended that Rechargeable OTC Hearing Aids be powered from an uninterruptible power supply or a battery.</p>
--	--	------------	--

3. Guidance and manufacturer's declaration-electromagnetic immunity-for all EQUIPMENT and SYSTEM that are not LIFE-SUPPORTING.

Guidance and manufacturer's declaration-electromagnetic immunity

The Rechargeable OTC Hearing Aids are intended for use in the electromagnetic environment specified below. The customer or user of this Medline Rechargeable OTC Hearing Aid should assure that it is used in such environment.

Immunity test	Conducted RF IEC 61000-4-6	Radiated RF IEC 61000-4-3
IEC 60601 test level	10 Vrms 150 kHz to 80 MHz	10 V/m 80 MHz to 2.5GHz
Compliance level	10 Vrms	10 V/m

Electromagnetic
environment
guidance

Portable and mobile RF communications equipment should be used no closer to any part of the Medline Rechargeable OTC Hearing Aids including cables, than the recommended separation distance calculated from the equation appropriate to the frequency of the transmitter.

Recommended separation distance

$$d=1.2\sqrt{P}$$

$$d=1.2\sqrt{P} \text{ 80MHz to 800MHz}$$

$$d=2.3\sqrt{P} \text{ 800MHz to 2.5GHz}$$

Where P is the maximum output power rating of the transmitter in watts (W) according to the transmitter manufacturer and d is the recommended separation distance in meters (m).

Field strengths from fixed RF transmitters, as determined by an electromagnetic site survey, ^a should be less than the compliance level in each frequency range. ^b

Interference may occur in the vicinity of equipment marked with the following symbol: 

Note 1:

At 80MHz and 800MHz, the higher frequency range applies.

Note 2:

These guidelines may not apply in all situation. Electromagnetic propagation is affected by absorption and reflection from structures, objects and people.

^a Fields strengths from fixed transmitters, such as basestations for radio (cellular/cordless) telephones and land mobile radios, a amateur radio, AM and FM radio broadcast and TV broadcast cannot be predicted theoretically with accuracy. To assess the electromagnetic environment due to fixed RF transmitters, an electromagnetic site survey should be considered. If the measured field strength in the location in which Rechargeable OTC Hearing Aids are used exceeds the applicable RF compliance level above, Rechargeable OTC Hearing Aids should be observed to verify normal operation. If abnormal performance is observed, additional measures may be necessary, such as reorienting or relocating Rechargeable OTC Hearing Aids.

^b Over the frequency range 150kHz to 80MHz, field strengths should be less than 3V/m.

4. Recommended separation distances between portable and mobile RF communications equipment and the acupuncture treatment device.

Rechargeable OTC Hearing Aids are intended for use in an electromagnetic environment in which radiated RF disturbances are controlled. The customer or the user of Rechargeable OTC Hearing Aids can help prevent electromagnetic interference by maintaining a minimum distance between portable and mobile RF communications equipment (transmitters) and Rechargeable OTC Hearing Aids as recommended below, according to the maximum output power of the communications equipment.

Rated maximum output power of transmitter (W)	Separation distance according to frequency of transmitter (m)		
	150KHz to 80MHz	80MHz to 800MHz	800MHz to 2.5GHz
0.01	0.12	0.12	0.23
0.1	0.38	0.38	0.73
1	1.2	1.2	2.3
10	3.8	3.8	7.3
100	12	12	23

For transmitters rated at a maximum output power not listed above, the recommended separation distance d in meters (m) can be estimated using the equation applicable to frequency of the transmitter, where P is the maximum output power rating of the transmitter in watts (W) according to the transmitter manufacturer.











Note1:

At 80MHz and 800MHz, the separation distance for the higher frequency range applies.

Note2:

These guidelines may not apply in all situations. Electromagnetic propagation is affected by absorption and reflection from structures, objects and people.

6.3 Normalized Symbols

	Follow operating instructions		
	Type B applied part		
	Disposal in accordance with Directive 2012/19/EU (WEEE)		
	Date of manufacture		Manufacturer information
	Serial number		USE BY
	Warning/Danger: Improper use might cause serious injuries		
	Medical Device		
<i>Storage/Transport</i> 	Permissible storage and transport temperature and humidity		
<i>Operating</i> 	Permissible operating temperature and humidity		
IP54	IP code of the device: this device's grade of against ingress of solid foreign objects – Dust-protected; the grade of water-proof is protected against splashing water		

Note: This hearing aid is produced in China for Medline, Industries, LP.

The device fulfills provisions of the Harmonize Standard as IEC 60601-1, IEC 60601-2-66, IEC 60118-13, EN ISO 10993-1/-5/-10 ENISO 14971, and FCC CFR47 Part 15 Subpart B, Class B.

6.4 Maintenance, Storage, and Disposal

Maintenance:

1. We do not authorize any institution or individual to maintain and/or repair the product. If you suspect that the products may be in question, please contact us immediately.
2. The user must not attempt any repairs to the device or any of its accessories. Please contact us for any repair needs.
3. Opening of the equipment by unauthorized agencies is not allowed and will terminate any claim to warranty. Warning : No modification of this equipment is permitted.

Storage:

1. Always store your devices in the Charging Case when not in use.
2. Do not store or expose the devices and/or case to extreme hot/cold temperatures, moist/humid environments, or shock/vibration.
3. Keep the devices and case in following environmental ranges:-10°C-55°C,10%-90%RH, 700-1060h Pa
4. The hearing aids should be fully charged before used for the first time. The hearing aids should be charged at least every 6 months if they are not used for an extended period of time.

Disposal:



Please dispose of the device in accordance with the directive 2012/19/EU – WEEE (Waste Electrical and Electronic Equipment). If you have any questions, please refer to your local authority responsible for waste disposal.

6.5 Warranty

Medline Industries, LP warrants this OTC behind-the-ear hearing aid against any defects in material and workmanship for a period of one (1) year after the date of purchase. Please note that Medline Industries, LP warrants only the hearing aid and the charging case; none of the included accessories are covered by this warranty. Excluding cases of freight damage, tampering, clear abuse, misuse, or accidents, Medline Industries, LP will, at its discretion, repair or replace this hearing aid, charging case, and/or its parts during the warranty period without charge. No representative or person is authorized to assume for us any liability in connection with the sale of the products, of Medline Industries, LP. This warranty gives you specific legal rights, and you may also have other rights that may vary from state to state. Prior to shipping any product, please contact either Medline Industries, LP at 1-800-MEDLINE or an authorized Medline sales representative with any warranty concerns.

6.6 Warranty Return

Please contact Medline Industries, LP at 1-800-MEDLINE or an authorized Medline sales representative to initiate the exchange of a damaged hearing aids or portable charging case under warranty. Medline will provide a return label to send the damaged hearing aids or portable charging case to Medline. Subject to the exclusions in section 6.5 Warranty, Medline will inspect the damaged hearing aids or portable charging case and exchange the in-warranty hearing aids or portable charging case with a new or refurbished unit at Medline's sole discretion.



Follow the QR Code to the left for a digital manual and product information.

Contact Us: 1-800-MEDLINE

Website: <https://athome.medline.com/rdr/hearingaids>



www.medline.com

Manufactured in China for Medline
Industries, LP, Three Lakes Drive, Northfield,
IL 60093 USA. **1-800-MEDLINE** V6 RF25HJI